

RS•RT CATALOGUE



technology
made in Italy 



EN

Experience at the service of innovation

The Varvel Group has been designing and producing power transmission systems for numerous areas of industry since 1955. "Know-how to do it": Varvel has the know-how needed to satisfy customers' requests in the best way possible. Thanks to over sixty years of accumulated experience, Varvel can offer customers a vast range of standard solutions and customise products for specific needs. The entire product range is designed and made in Italy and sold worldwide through two subsidiaries (in the USA and India) and a global network of over 100 commercial partners.

UNI EN ISO 9001:2015
UNI EN ISO 14001:2015
BS OHSAS 18001:2007



EC DIRECTIVE 2014/34/EC (ATEX)



RS - RT

WORM GEARBOXES

single-stage, helical/worm, two-stages
aluminium / cast iron housing and covers
shaft-mount, foot and flange mounting



TABLE OF CONTENTS

Product description	2-4
Symbols	5
Modular system.....	6-7
Flexible coupling G	8
Flexible coupling selection	9
NEMA Flanges & coupling	10
IEC Flanges & coupling	11
VARsize Electronic catalogue - 3D models.....	12
Product designations	13
Input arrangements.....	14
Mounting positions	15-17
Service factors	18-20
Weights - Oil quantity - Input loads	21
Output loads	22-23

Selection tables

RS-RT Single-stage worm gearboxes.....	24-27
RA-TA Helical / worm gearboxes	28-30
RS/RS-RT/RT Two-stage worm gearboxes	31

Dimensions

RS Single-stage	32-33
RA Helical/worm	34-35
RS/RS Two-stage worm	36-37
Alternative mountings	38-39
RS Accessories.....	40-41
RT Single-stage	42-43
TA Helical/worm.....	44-45
RT/RT Two-stage worm.....	46-47
RT Accessories.....	48-49
XA Single-stage attachment	50

General information

Back driving - Reversibility - Irreversibility.....	51
Gearing data -	51
Direction of rotation.....	52
Component parts	53
Conversion factors.....	54
Operation and Maintenance abstract	54

RS-RT Worm Gearboxes

Product description



RS & RT - Single-stage worm gearboxes

The gearboxes are made as standard with input hub for various motor adapters and either side covers allow feet, output flanges and torque arm easy fitting.

On demand, input Viton oil seals allow trouble-free operation with 2-pole standard AC, DC and servo motors, and Silicone oil seals for low temperature running.

Gearboxes are delivered filled with synthetic long-life oil (ISO VG 320 Grade) as standard, for ambient temperature $+4 / +131$ °F ($-20 / +55$ °C), oil quantities as recommended on page 21, valid for all mounting positions.

No vent plug style and lubrication-for-life is factory filled.

Selection data are intended for service factor SF1.0, i.e. 8-10 running hours per day, uniform load, 10,000 working hours, less than 6 start/stops per hour and room temperature ranging from 60 to 95 °F (15 to 35 °C).

RA & TA - Helical/worm gearboxes

RA and TA gearboxes are made of an independent single-stage helical gearbox FXA fitted on a standard FRS or FRT gearbox input, allowing greater output torque and higher efficiency than the single-stage FRS and FRT gearbox with equivalent ratio.

FXA input of sizes 63, 71 and 80 is metric, while the size FXA100 has NEMA and IEC adapters.

Both gearboxes are independently lubricated with synthetic long-life oil.

RS/RS & RT/RT - Two-stage worm gearboxes

RS/RS and RT/RT gearboxes are made of two standard gearboxes RS or RT and offer a full selection of high reduction ratios to get even lower output speeds.

Both gearboxes are independently lubricated with synthetic long-life oil.

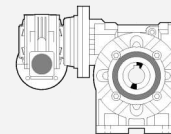
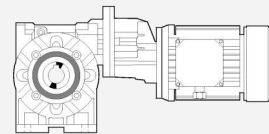
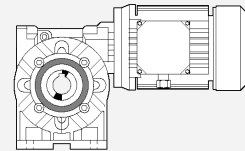

Worm Gearboxes - Series RS - RT

Product description



AS & AD - Output shafts

All gearboxes are manufactured with hollow output shaft as standard.
Single AS or double AD solid output shafts can be supplied. on demand
The ASC safety shield fitted on the opposite side of the AS extension, is available on demand.

BR & BRV - BT & BTV - Torque arms

The gearbox basic version works as shaft mounted unit.
The torque arm, standard BR (for RS) and BT (for RT), or BRV (for RS) and BTV (for RT) with Vulkollan vibration-damping bushing, is made of white galvanized extra thick plate.

TLE & TLI - Torque limiter -

The torque limiter and safeguard device, TLI built-in inside the gearbox and TLE fitted into the hollow output shaft of a regular gearbox, allows easy torque adjustments, full gearbox safeguard against unexpected overload conditions, simple hand release, and manual operation in case of power supply failure.

The torque limiter device can be rated for RA and TA helical/worm gear and for two-stage worm gears full capacity but torque limitation is possible at some low speeds to be however approved by our engineers.

The factory preset slipping torque can be adjusted from the maximum preset torque down to zero.

Shaft rotation restarts automatically as soon as torque value is lower than the preset value.

Dimensions

All dimensions and units of measurement are referred to the imperial system and metric is printed in green where applicable

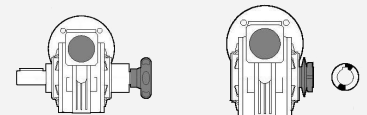
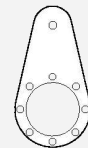

.Directive ATEX

The European Directive 94/9/EC-ATEX does not relate to electric devices only but to all machines and driving units destined, alone or combined, to operate in potentially explosive environments within the European Community territory.

The VARVEL gearboxes are qualified for installation in potentially explosive atmospheres of:

- Zones of Group II,
- Category 2 (or 3),
- Explosion hazard with gas presence (Zone 1 or 2),
- Explosion hazard with combustible dust presence (Zone 21 or 22).

The units VARVEL-ATEX are identified by the additional marking:

 II 2 GD ck IP66 c c T_{max}=135 °C

RS-RT Worm Gearboxes

Product description

GENERAL SPECIFICATIONS																																			
Range	Sizes: RS (9x), RT (7x) Reduction ratios: 55 Max. output torque: 27,400 in-lbs																																		
Sizing	According to BS721 10,000 hrs average lifetime with service factor SF1																																		
Housing, Covers	Pressure die cast aluminium up to size 85 and cast iron from size 110 up																																		
Input:	Die cast aluminium coupling for sizes 3, 5, 6 and alloyed steel from size 8 Plug-in key/keyway version on demand																																		
Gears	Worms of alloyed steel, case hardened and tooth profile ZI ground Wheels of bronze on cast iron hub																																		
Shafts & Keys	Alloyed steel Shafts h6 - Bores E8 Keys according to DIN6885 B1																																		
Bearings	Ball or roller types																																		
Oil seals	NBR - Nitrile Butadiene Rubber type as standard FKM - Fluor elastomer Viton type on demand VMQ - Vinyl-methyl-silicone rubber type on demand with additional anti-dust lip, according to DIN 3760																																		
Lubricant	Synthetic long-life oil Grade ISO VG 320																																		
Tolerances																																			
	<table border="1"> <thead> <tr> <th rowspan="2"></th> <th rowspan="2">Diameter</th> <th colspan="2">Tolerance</th> </tr> <tr> <th>[in]</th> <th>[mm]</th> </tr> </thead> <tbody> <tr> <td rowspan="2">Solid shaft</td> <td>U $\varnothing 0.5 \dots \varnothing 1.5$</td> <td>0 / -0.0005</td> <td rowspan="2">ISO g6</td> </tr> <tr> <td>$\varnothing > 1.5 \dots \varnothing 2.75$</td> <td>0 / -0.0010</td> </tr> <tr> <td rowspan="5">Hollow shaft</td> <td>U $\varnothing 0.625$</td> <td>+0.0007 / 0</td> <td rowspan="4">ISO H7</td> </tr> <tr> <td>$\varnothing 0.75 \dots \varnothing 1.0$</td> <td>+0.0008 / 0</td> </tr> <tr> <td>$\varnothing 1.25 \dots \varnothing 1.625$</td> <td>+0.0010 / 0</td> </tr> <tr> <td>$\varnothing 2.0 \dots \varnothing 2.75$</td> <td>+0.0012 / 0</td> </tr> <tr> <td>R $\varnothing 0.625 \dots \varnothing 2.75$</td> <td>+0.0079 / 0</td> <td>+0.2 / 0</td> </tr> <tr> <td></td> <td>S $\varnothing 0.625 \dots \varnothing 0.75$</td> <td>+0.0012 / 0</td> <td rowspan="3">ISO H9</td> </tr> <tr> <td></td> <td>$\varnothing 1.0 \dots \varnothing 1.625$</td> <td>+0.0014 / 0</td> </tr> <tr> <td></td> <td>$\varnothing 2.0 \dots \varnothing 2.75$</td> <td>+0.0017 / 0</td> </tr> </tbody> </table>		Diameter	Tolerance		[in]	[mm]	Solid shaft	U $\varnothing 0.5 \dots \varnothing 1.5$	0 / -0.0005	ISO g6	$\varnothing > 1.5 \dots \varnothing 2.75$	0 / -0.0010	Hollow shaft	U $\varnothing 0.625$	+0.0007 / 0	ISO H7	$\varnothing 0.75 \dots \varnothing 1.0$	+0.0008 / 0	$\varnothing 1.25 \dots \varnothing 1.625$	+0.0010 / 0	$\varnothing 2.0 \dots \varnothing 2.75$	+0.0012 / 0	R $\varnothing 0.625 \dots \varnothing 2.75$	+0.0079 / 0	+0.2 / 0		S $\varnothing 0.625 \dots \varnothing 0.75$	+0.0012 / 0	ISO H9		$\varnothing 1.0 \dots \varnothing 1.625$	+0.0014 / 0		$\varnothing 2.0 \dots \varnothing 2.75$
	Diameter			Tolerance																															
		[in]	[mm]																																
Solid shaft	U $\varnothing 0.5 \dots \varnothing 1.5$	0 / -0.0005	ISO g6																																
	$\varnothing > 1.5 \dots \varnothing 2.75$	0 / -0.0010																																	
Hollow shaft	U $\varnothing 0.625$	+0.0007 / 0	ISO H7																																
	$\varnothing 0.75 \dots \varnothing 1.0$	+0.0008 / 0																																	
	$\varnothing 1.25 \dots \varnothing 1.625$	+0.0010 / 0																																	
	$\varnothing 2.0 \dots \varnothing 2.75$	+0.0012 / 0																																	
	R $\varnothing 0.625 \dots \varnothing 2.75$	+0.0079 / 0	+0.2 / 0																																
	S $\varnothing 0.625 \dots \varnothing 0.75$	+0.0012 / 0	ISO H9																																
	$\varnothing 1.0 \dots \varnothing 1.625$	+0.0014 / 0																																	
	$\varnothing 2.0 \dots \varnothing 2.75$	+0.0017 / 0																																	

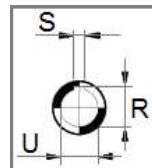

Worm Gearboxes - Series RS - RT

Symbols

Symbol	Description	Formula
F_r [lb]	Application overhung load (external OHL)	
F_{r1} [lb]	Catalogue input overhung load (gearbox input OHL)	
F_{r2} [lb]	Catalogue output overhung load (gearbox output OHL)	
SF	Service factor	$M_2 / M_{(app)}$
R	Reduction ratio of single stage units	
R_1, R_2	Reduction ratio of 1 st and 2 nd stage in multi-stage units	
Lub [qt]	Lubricant	
M_2 [in-lb]	Gearbox output torque	$63025 \times \text{HP} \times \text{eff.} / \text{rpm}$
$M_{(app)}$ [in-lb]	Application torque	
n_1 [rpm]	Input speed	
n_2 [rpm]	Output speed	
P_1 [HP]	Motor power @ 60Hz	$63025 \times \text{HP} \times \text{eff.} / \text{rpm}$
W [lb]	Average value for foot mounting & reduction ratio	
η	Efficiency	

RS-RT Worm Gearboxes

Modular system

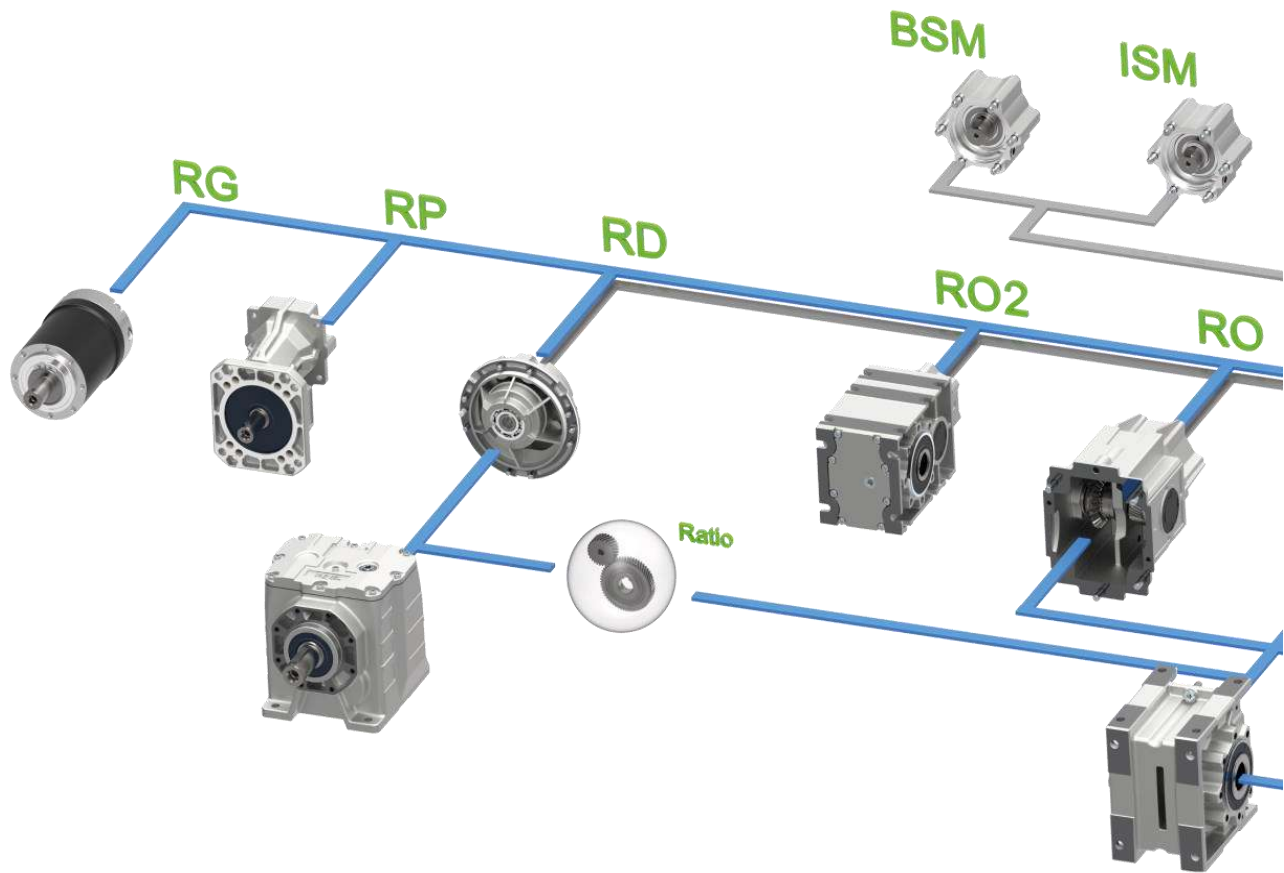

Worm Gearboxes RS-RT

Modular system

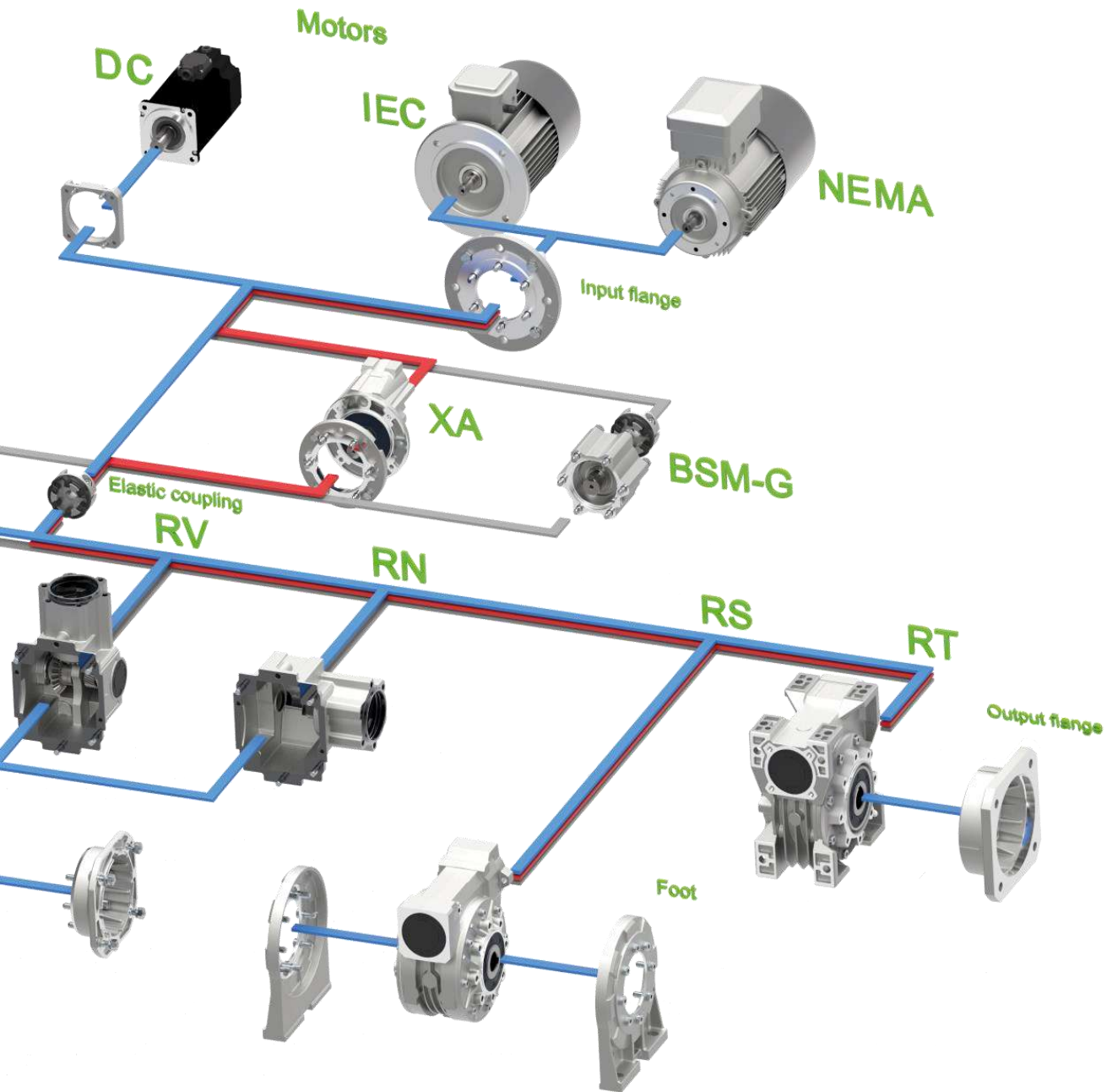

RS-RT Worm Gearboxes

Flexible coupling

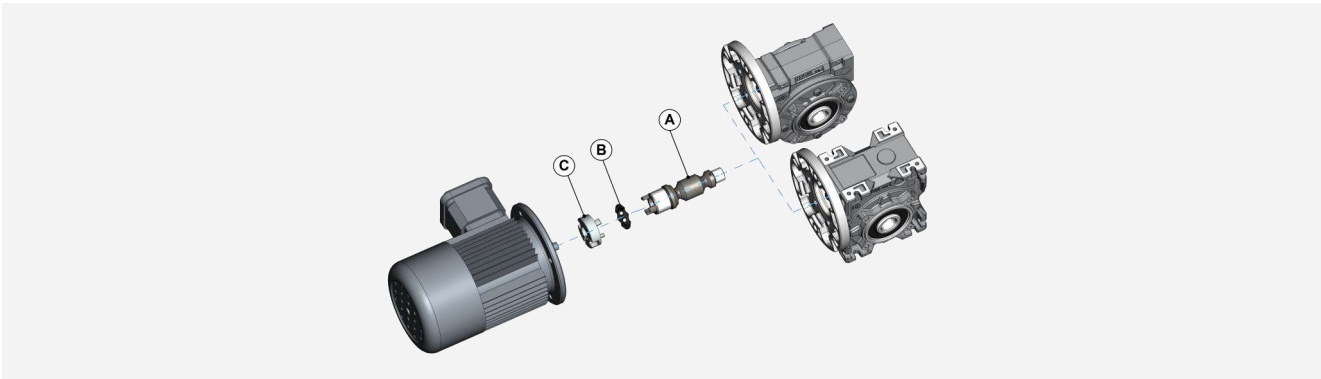

Flexible coupling system

A) Gearbox-side coupling hub

- Material: steel
- One-piece machined with input pinion shaft
- Two bearing setting
- Not altered gearbox casing dimensions

B) Spider

- Material: Polyarylamide Thermo-plastic Elastomer
- External tooth connection
- Hardness 90 Shore D
- Temperature range -22/+275°F (-30/+135°C)

C) Motor-side coupling hub

- Material: Aluminium die cast (G3, G5, G6) Steel (GS3, GS5, GS6, GS8)
- Dynamic balancing
- Fitting: Clamp (G3, G5, G6) Key (GS3, GS5, GS6, GS8)

Modular input flange system

- Material Aluminium up to NEMA TC180 & IEC112 Cast iron from NEMA TC200 & IEC132
- Flanges according to NEMA C and TC IEC 72 / DIN42948 Square shape for brushless and DC motor mount

Advantages of unique integrated elastomer jaw coupling

- One gearbox for multiple motor frame sizes and convertible into NEMA, IEC, Brushless, DC motor input with specific adapter/coupling kits and modular input flange system
- Greater flexibility and increased stock rotation
- Elimination of fretting corrosion common to quill mount
- Elimination of key/keyway wear in dynamic applications
- Zero backlash on motor-to-reducer connection
- Reduction of efficiency losses due to motor mounting misalignment
- High torsional rigidity
- High vibration damping

Flexible coupling program

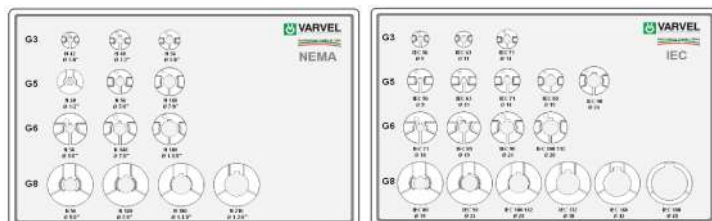

Worm Gearboxes - Series RS - RT

Flexible coupling selection

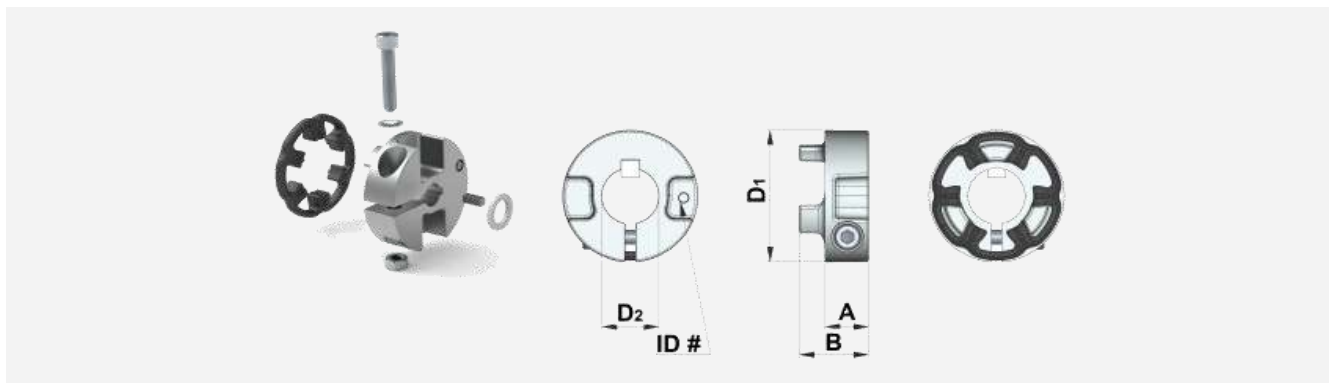

Coupling Size	IEC NEMA	Kit Code	RS - RT Size	Mt [Nm]	Mt1 [Nm]	Mt2 [Nm]	A [mm]	B [mm]	D1 [mm]	D2 [mm/inch]	ID#
G3	NEMA	KG3.N42//X	28-40	4.5 - 6	16	8 - 10	11	19	30	3/8"	3N42
		KG3.N48/X	40	4.5 - 6	18	10 - 12			36	1/2"	3N48
KG3.N56/X		40	7 - 8.5	30	20 - 24	36			5/8"	3N56	
G5	IEC	KG3.009/X	28-40	4.5 - 6	15	8 - 10	14.5	23	30	9	309
		KG3.011/X	28-40	4.5 - 6	15	8 - 10			30	11	311
G6	NEMA	KG3.014/X	40	7 - 8.5	28	18 - 2	19.5	31.5	36	14	314
		KG5.N56/X	50-60	8.9 - 10	45	30 - 35			58	45	5/8"
G5	IEC	KG5.N140/X	60		60	40 - 45	19.5	31.5		52	7/8"
		KG5.011/X	50-60	15	8 - 10	45			11	511	
G6	IEC	KG5.014/X	50-60	30	12 - 17	19.5	31.5	45	14	514	
		KG5.019/X	50-60	40	20 - 25			45	19	519	
G6	NEMA	KG5.024/X	60	70	30 - 40	19.5	31.5	52	24	524	
		KG6.N56/X	70-85-110	15.3 - 18	50			---	58	5/8"	6N56
G6	IEC	KG6.N140/X	70-85-110		85	---	19.5	31.5		7/8"	6N140
		KG6.N180	70-85-110	200	---	1-1/8"			6N180		
G6	IEC	KG6.014/X	70	60	30 - 40	19.5	31.5	58	14	614	
		KG6.019/X	70-85-110	90	50 - 65				19	619	
G6	IEC	KG6.024/X	70-85-110	130	85 - 100	19.5	31.5	58	24	624	
		KG6.028/X	70-85-110	180	100 - 120				28	628	

../X - Code of coupling with new IXEF black-spider

Mt - Tightening torque

Mt1 - Transmissible torque with key

Mt2 - Transmissible torque without key

RS-RT Worm Gearboxes

NEMA flanges and flexible couplings

RS - RT	Flange Size	NEMA Frame	Flange Kit Code	Coupling	
				Type	Kit Code
RS-RT 28	FM 28	42 C 48 C	K530.207.N048 K530.207.N048	G3 \varnothing 3/8" G3 \varnothing 1/2"	KG3.N042/X KG3.N048/X
RS-RT 40	FM 40	42 C 48 C 56 C	K531.227.N048 K531.227.N048 K531.227.N056	G3 \varnothing 3/8" G3 \varnothing 1/2" G3 \varnothing 5/8"	KG3.N042/X KG3.N048/X KG3.N056/X
RS-RT 50	FM 50	56 C	K532.227.N056	G5 \varnothing 5/8"	KG5.N056
RS-RT 60	FM 60	56 C 140 TC	K539.227.N056 K539.227.N056	G5 \varnothing 5/8" G5 \varnothing 7/8"	KG5.N056 KG5.N140
RS-RT 70	FM 70	56 C 140 TC 180 TC	K533.227.N056 K533.227.N056 K533.227.N180	G6 \varnothing 5/8" G6 \varnothing 7/8" G6 \varnothing 1-1/8"	KG6.N056/X KG6.N140/X KG6.N180/X
RS-RT 85	FM 85	56 C 140 TC 180 TC	K534.227.N056 K534.227.N056 K534.227.N180	G6 \varnothing 5/8" G6 \varnothing 7/8" G6 \varnothing 1-1/8"	KG6.N056/X KG6.N140/X KG6.N180/X
RS-RT 110	FM 110	56 C 140 TC 180 TC	K535.227.N056 K535.227.N056 K535.227.N180	G6 \varnothing 5/8" G6 \varnothing 7/8" G6 \varnothing 1-1/8"	KG6.N056/X KG6.N140/X KG6.N180/X
RS 130	FM 130	56 C 140 TC 180 TC	K536.227.N056 K536.227.N056 K536.227.N180	\varnothing 5/8" # \varnothing 7/8" # \varnothing 1-1/8" #	--- --- ---
RS 150	FM 130	56 C 140 TC 180 TC 210 TC	K537.227.N056 K537.227.N056 K537.227.N180 K537.227.N180	\varnothing 5/8" # \varnothing 7/8" # \varnothing 1-1/8" # \varnothing 1-3/8" #	--- --- --- ---
XA 63	FM 40	* IEC56 * IEC63	K531.206.120 K531.206.140	\varnothing 9 mm # \varnothing 11 mm #	--- ---
XA 71	FM 50	* IEC71	K532.206.160	\varnothing 14 mm #	---
XA 80	FM 70	* IEC80 * IEC90	K533.206.200 K533.206.200	\varnothing 19 mm # \varnothing 24 mm #	--- ---
XA 100	FM 85	56 C 140 TC 180 TC	K334.227.N056 K334.227.N056 K334.227.N180	G6 \varnothing 5/8" G6 \varnothing 7/8" G6 \varnothing 1-1/8"	KG6.N056/X KG6.N140/X KG6.N180/X

..X - Code of coupling with IXEF black-spider
 # - Key/keyway motor fitting
 * - NEMA adapters not available, IEC input only

Worm Gearboxes - Series RS - RT

IEC flanges and flexible coupling

RS - RT - XA	Fange	IEC	Flange Kit-code		Coupling	
			Flange B5	Flange B14	Type	Kit Code
RS-RT 28	FM 28	IEC56 IEC63	K530.206.120 K530.206.140	K530.206.080 K530.206.090	G3 ø9 G3 ø11	KG3.009/X KG3.011/X
RS-RT 40	FM 40	IEC56 IEC63 IEC71	K531.206.120 K531.206.140 K531.206.160	K531.206.080 K531.206.090 K531.206.105	G3 ø9 G3 ø11 G3 ø14	KG3.009/X KG3.011/X KG3.014/X
RS-RT 50	FM 50	IEC63 IEC71 IEC80	K532.206.140 K532.206.160 K532.206.200	K532.206.090 K532.206.105 K532.206.120	G5 ø11 G5 ø14 G5 ø19	KG5.011/X KG5.014/X KG5.019/X
RS-RT 60	FM 60	IEC71 IEC80 IEC90	K539.206.160 K539.206.200 K539.206.200	K539.206.105 K539.206.120 K539.206.140	G5 ø14 G5 ø19 G5 ø24	KG5.014/X KG5.019/X KG5.024/X
RS-RT 70	FM 70	IEC71 IEC80 IEC90 IEC100	K533.206.160 K533.206.200 K533.206.200 K533.206.250	K533.206.105 K533.206.120 K533.206.140 K533.206.160	G6 ø14 G6 ø19 G6 ø24 G6 ø28	KG6.014/X KG6.019/X KG6.024/X KG6.028/X
RS-RT 85	FM 85	IEC80 IEC90 IEC100/112	K534.206.200 K534.206.200 K534.206.250	K534.206.120 K534.206.140 K534.206.160	G6 ø19 G6 ø24 G6 ø28	KG6.019/X KG6.024/X KG6.028/X
RS-RT 110	FM 110	IEC90 IEC100/112 IEC132	K535.206.200 K535.206.250 K535.206.300	--- K535.206.160 K535.206.200	G6 ø24 G6 ø28 ø38 #	KG6.024/X KG6.028/X ---
RS 130	FM 130	IEC100/112 IEC 132	K536.206.250 K537.206.300	--- K536.206.200	ø28 # ø38 #	--- ---
RS 150	FM 150	IEC100/112 IEC 132 IEC 160	K536.206.250 K537.206.300 K537.206.350	K536.206.200 K536.206.250 ---	ø28 # ø38 # ø42 #	--- --- ---
XA 63	FM 40	IEC56 IEC63	K531.206.120 K531.206.140	K531.206.080 K531.206.090	ø9 # ø11 #	--- ---
XA 71	FM 50	IEC71	K532.206.160	K532.206.105	ø14 #	---
XA 80	FM 70	IEC80 IEC90	K533.206.200 K533.206.200	K533.206.120 K533.206.140	ø19 # ø24 #	--- ---
XA 100	FM 85	IEC80 IEC90 IEC100/112	K534.206.200 K534.206.200 K534.206.250	K534.206.120 K534.206.140 K534.206.160	G6 ø19 G6 ø24 G6 ø28	KG6.019/X KG6.024/X KG6.028/X

/X - Code of coupling with IXEF black-spider
- Key/keyway motor fitting

RS-RT Worm Gearboxes

VARsize Electronic catalogue - 3D models



Modularity and flexibility

have been leading the design of VARVEL products since the years 2000: this way, the kit-concept gearbox was carried out allowing anyone to assemble the unit in few minutes with standard tooling.

This feature provides the highest flexibility to VARVEL's distributors and resellers who, thanks to a limited kit selection, are able to immediately configure the required product.

VARsize® selection program, available from our web-site

www.varvel.com/en/varsize

allows a friendly sizing of VARVEL product range.

2D/3D Drawings

A guided selection lets 2D/3D models downloaded for the most popular CAD systems.

Guided selection

This option returns a list of applicable product configurations upon a given sequence of application parameters (power, output torque, rpm, service factor etc.).

A PDF data sheet featuring performance data and dimensional drawings is generated for each configuration, as well as the 3D model and 2D drawings.

- Pick a configuration identifying inch or metric units
- Enter your applications information or requirements
- The program selects a range of appropriate solutions
- Pick the one you want and download 2D/3D drawings
- Print out a technical data sheet with all specifications of the selected unit

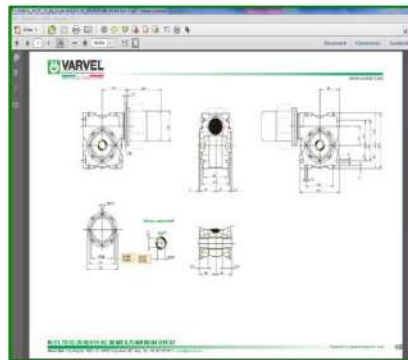
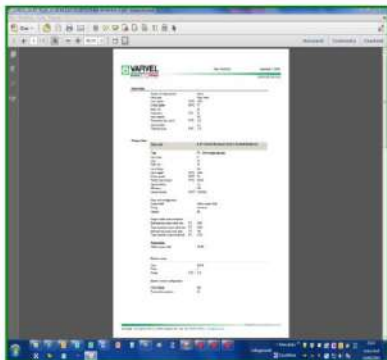

Worm Gearboxes - Series RS - RT

Product designation

Example: FRT-G50 B3 1:20 N56 AC1.0"												
F	RT-G			50	B3			1:20	N56		AC	1.0"
	TYPE (coupling input) RT-G - Universal Mount TA-G - Helical/worm RT/RT-G - Double worm RS-G - Original Mount RA-G - Helical/worm RS/RS - Double worm				MOUNTING POSITION RS - Pages 15, 16 RT - Page 17						OUTPUT SHAFT AC - Hollow AS - Solid single output AD - Solid dual output	
INPUT TYPE	SIZE			RATIO 1:			MOTOR ADAPTER		SHAFT DIMENSIONS			
	A)	B)	C)	A)	B)	C)	NEMA	IEC	Size	Dia. in	Dia. mm	
M - Motorized unit	28	63/40	28/28	5	32	280	N42	56	28	0.625"	14	
F - With motor flange	40	63/50	28/40	7	44	420	N48	63	40	0.75"	20 19 18	
S - Without motor flange	50	63/60	28/50	10	63	560	N56	71	50	1.0"	25 24	
nil - Solid input	60	71/50	28/60	15	95	784	N140	80	60	1.125"	25	
	70	71/60	40/70	20	126	1120	N180	90	70	1.25"	30 28 25	
	85	71/70	40/85	28	176	1586	N210	100/112	85	1.375"	35 32	
	110	71/85	50/110	40	252	2240		132	110	1.625"	42	
	130	80/60	60/130	56	309	2800		160	130	1.75"	48	
	150	80/70	70/150	70	353	4000			150	2.0"	55	
		80/85		80	441	5600						
		80/110		100	504	8000						
		100/110			630	10000						
		100/130										
		100/150										

A) - Single worm gearboxes
B) - Helical/worm gearboxes
C) - Double worm gearboxes

OPTIONS

AS/AD - Single / double sided solid output shaft	GRM - Reduced end play
BR/BRV - Plain / Vulkollan-bush torque arm	LNS - Non-standard lubrication
CS - Non-standard output bearings	TLE/TLI - Internal / external torque limiter
F/FL - Additional output flange bolt on body side	VB - NDE (not drive end) worm shaft extension

Unless otherwise requested, the fitting side of output flanges and optional items is on the right side of the gearbox when seen from input as standard.

RS-RT Worm Gearboxes

Input arrangements

FRS FRT	28	40	50	60	70	85	110	130	150
NEMA42	G3	G3	---	---	---	---	---	---	---
NEMA48	---	G3	---	---	---	---	---	---	---
NEMA56	---	G3	G5	G5	G6	G6	G6	---	---
NEMA140	---	---	---	G5	G6	G6	G6	■	■
NEMA180	---	---	---	---	G6	G6	G6	■	■
NEMA210	---	---	---	---	---	---	---	---	■
FXA	63	71	80	100					
NEMA56	---	---	---	G6					
NEMA140	---	---	---	G6					
NEMA180	---	---	---	G6					

FRS FRT	28	40	50	60	70	85	110	130	150
IEC56	G3	G3	---	---	---	---	---	---	---
IEC63	G3	G3	G5	---	---	---	---	---	---
IEC71	---	G3	G5	G5	G6	---	---	---	---
IEC80	---	---	G5	G5	G6	G6	---	---	---
IEC90	---	---	---	G5	G6	G6	G6	---	---
IEC100	---	---	---	---	G6	G6	G6	■	■
IEC112	---	---	---	---	---	G6	G6	■	■
IEC132	---	---	---	---	---	---	■	■	■
IEC160	---	---	---	---	---	---	---	---	■
FXA	63	71	80	100					
IEC56	■	---	---	---					
IEC63	■	---	---	---					
IEC71	---	■	---	---					
IEC80	---	---	■	G6					
IEC90	---	---	■	G6					
IEC100	---	---	---	G6					
IEC112	---	---	---	G6					

G3, G5, G6 - Aluminium coupling, standard

GS3, GS5, GS6, GS8 - Steel coupling, on demand

■ - IEC flange and metric quill input (key/keyway fitting) as standard. Other cases on demand

Worm Gearboxes - Series RS - RT

RS, RA. RS/RS

Mounting positions

Output configuration

same configurations for SA, IA, DA, FA, FB, PA, PB mountings: refer to page 38 for dimensions.

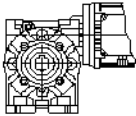
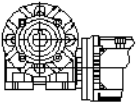
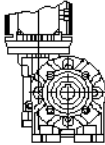
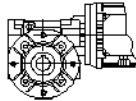
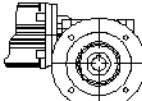
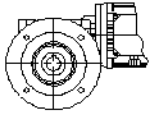
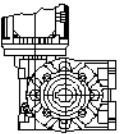
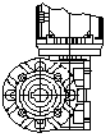
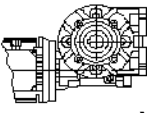
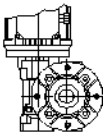
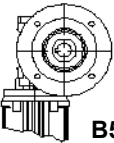
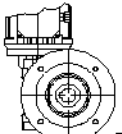
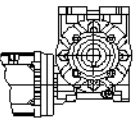
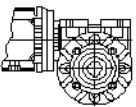
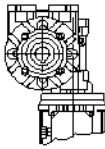
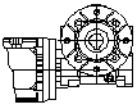
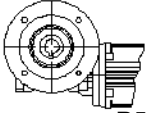
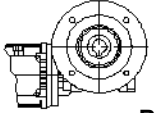
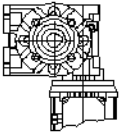
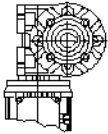
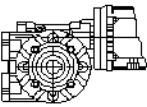
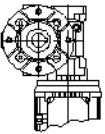
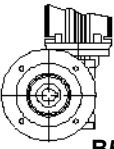
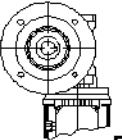
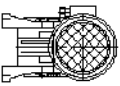
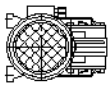
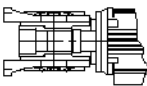
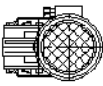
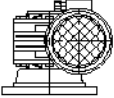
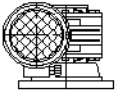
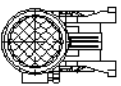
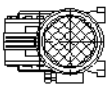
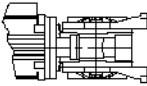
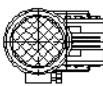
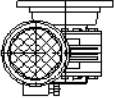
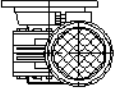
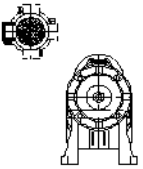
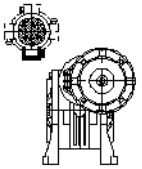
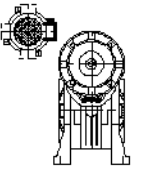
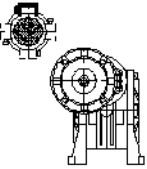
S (SA)	I (IA)	D (DA)	PC - PC	FL (FA,FB) & (PA,PB)	
 B3 (std)	 B3 (std)	 B3 (std)	 B5 (std)	 B5 (std)	 B5i
 V5	 V5	 V5	 B5	 B5a	 B5ai
 B8	 B8	 B8	 B5	 B5b	 B5bi
 V6	 V6	 V6	 B5	 B5c	 B5ci
 B6	 B6	 B6	 V1	 V1	 V1i
 B7	 B7	 B7	 V3	 V3	 V3i
Helical/Worm Input Configuration (RA)	 10 (std)	 11	 12	 13	











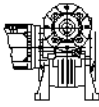
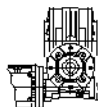
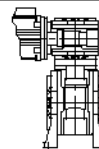
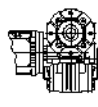
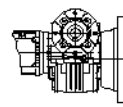
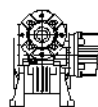
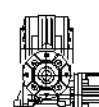
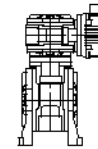
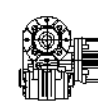
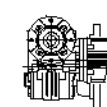
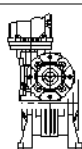
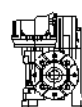
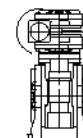

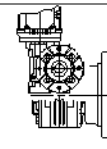
RS-RT Worm Gearboxes

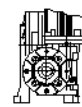
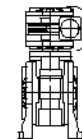
Mounting positions

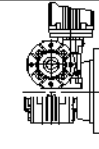
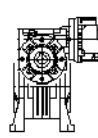
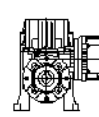
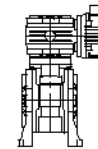
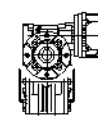
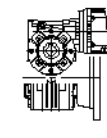
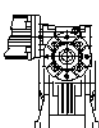
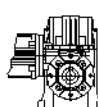
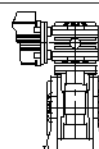
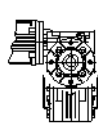
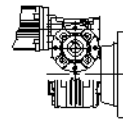
RS/RS

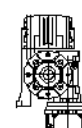
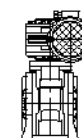
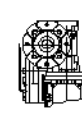
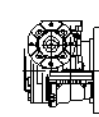
Two-stage input configuration

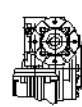
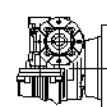

same configurations for SA, IA, DA, FA, FB, PA, PB mountings: refer to page 38 for dimensions.

	S (SA)	I (IA)	D (DA)	PC (PA, PB)	FL (FA, FB)
11					
12					
13					
14					
15					
16					
17					
18					

Worm Gearboxes - Series RS - RT

RT, TA, RT/RT

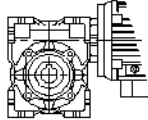
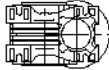
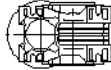
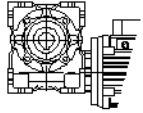
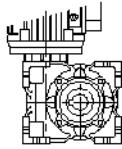
Mounting positions

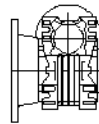
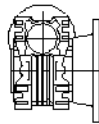
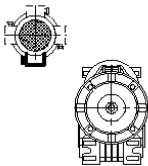
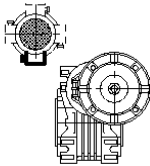
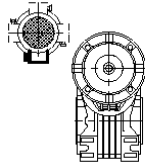
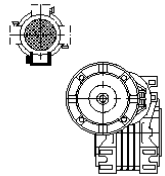
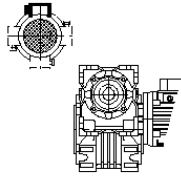
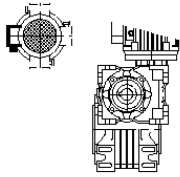
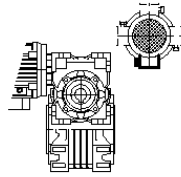
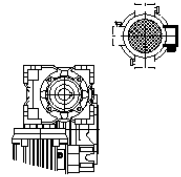
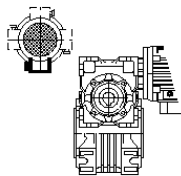
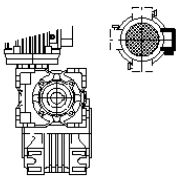
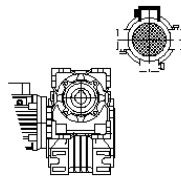
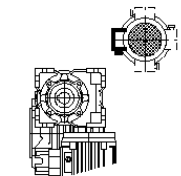
Output configuration (RT, TA, RT / RT)	<p>B3 (std)</p> 	 <p>B6</p>	 <p>B7</p>	 <p>B8</p>
	 <p>V5</p>	 <p>V6</p>	 <p>F (std)</p>	 <p>Fi</p>
Helical/worm input configuration (TA)	 <p>10 (std)</p>	 <p>11</p>	 <p>12</p>	 <p>13</p>
Two-stage worm input configuration (RT/RT)	 <p>20 (std)</p>	 <p>21</p>	 <p>22</p>	 <p>23</p>
	 <p>24</p>	 <p>25</p>	 <p>26</p>	 <p>27</p>

RS-RT Worm Gearboxes

Service factors

GEARBOX SERVICE FACTOR

Service factor is the ratio between M_2 (gearbox maximum output torque) and $M_{(app)}$ (application torque), and it must be bigger than the related Application factor listed below.

Service factor SF1.0 is meant as typical of 16 hours/day operation, with uniform load, starts/ stops lower than 6 per hour and ambient temperature between 60 and 95 °F.

For max. ambient temperature exceeding 100 °F or below 32 °F, please ask Customer Service.

Application	Load duration (hrs/day)			Application	Load duration (hrs/day)		
	3 -	3 - 10	10 +		3 -	3 - 10	10 +
Agitators (mixers)				Elevators			
Pure liquids	1.00	1.00	1.25	Bucket	1.00	1.25	1.50
Liquids and solids	1.00	1.00	1.50	Centrifugal discharge	1.00	1.00	1.25
Liquids - variable density	1.00	1.25	1.50	Escalators	1.00	1.00	1.25
Blowers				Freight	1.00	1.25	1.50
Centrifugal	1.00	1.00	1.25	Gravity discharge	1.00	1.00	1.25
Lobe	1.00	1.25	1.50	Extruders			
Vane	1.00	1.25	1.50	General	1.50	1.50	1.50
Brewing and distilling				Plastics			
Bottling machinery	1.00	1.25	1.25	Variable speed drive	1.50	1.50	1.50
Brew kettles - continuous duty	1.25	1.25	1.25	Fixed speed drive	1.75	1.75	1.75
Cookers - continuous duty	1.25	1.25	1.25	Rubber			
Mash tubs - continuous duty	1.25	1.25	1.25	Continuous screw operation	1.75	1.75	1.75
Scale hopper - frequent starts	1.25	1.25	1.25	Intermittent screw operation	1.75	1.75	1.75
Can filling machine	1.00	1.00	1.25	Fans			
Car dumpers	1.50	1.75	2.00	Centrifugal	1.00	1.00	1.25
Car pullers	1.00	1.25	1.50	Cooling towers	2.00	2.00	2.00
Clarifiers	1.00	1.00	1.25	Forced draft	1.25	1.25	1.25
Classifiers	1.00	1.25	1.50	Induced draft	1.50	1.50	1.50
Clay working machinery				Industrial and mine	1.50	1.50	1.50
Brick press	1.50	1.75	2.00	Feeders			
Briquette machine	1.50	1.75	2.00	Apron	1.00	1.25	1.50
Pug mill	1.00	1.25	1.50	Belt	1.00	1.25	1.50
Compactors	2.00	2.00	2.00	Disc	1.00	1.00	1.25
Compressors				Reciprocating	1.50	1.75	2.00
Centrifugal	1.00	1.00	1.25	Screw	1.00	1.25	1.50
Lobe	1.00	1.25	1.50	Food industry			
Reciprocating, multi-cylinder	1.50	1.50	1.75	Cereal cooker	1.00	1.00	1.25
Reciprocating, single-cylinder	1.75	1.75	2.00	Dough mixer	1.25	1.25	1.50
Conveyors				Meat grinders	1.25	1.25	1.50
- General purpose				Slicers	1.25	1.25	1.50
Uniformly loaded or fed	1.00	1.00	1.25	Generators and exciters	1.00	1.00	1.25
- Heavy duty				Hammer mills	1.75	1.75	2.00
Not uniformly fed	1.00	1.25	1.50	Hoists			
- Reciprocating or shaker	1.50	1.75	2.00	Heavy duty	1.25	1.75	2.00
Crusher				Medium duty	1.25	1.25	1.50
Stone or ore	1.75	1.75	2.00	Skip hoist	1.25	1.25	1.50
Dredges				Laundry			
Cable reels .	1.25	1.25	1.50	Tumblers	1.25	1.25	1.50
Conveyors	1.25	1.25	1.50	Washers	1.50	1.50	2.00
Cutter head drives	2.00	2.00	2.00	Lumber industry			
Pumps	2.00	2.00	2.00	Barkers			
Screen drives	1.75	1.75	2.00	Spindle feed	1.25	1.25	1.50
Stackers	1.25	1.25	1.50	Main drive	1.75	1.75	1.75
Winches	1.25	1.25	1.50	Conveyors			
				Burner	1.25	1.25	1.50
				Main or heavy duty	1.50	1.50	1.50
				Main log	1.75	1.75	2.00
				Re-saw, merry-go-round	1.25	1.25	1.50

Worm Gearboxes - Series RS - RT

Service factors

Application	Load duration (hrs/day)			Application	Load duration (hrs/day)		
	3 -	3 - 10	10 +		3 -	3 - 10	10 +
Conveyors				Mixers			
Slab	1.75	1.75	2.00	Concrete	1.25	1.25	1.50
Transfer	1.25	1.25	1.50	Paper mills			
Chains				Agitator (mixer)	1.50	1.50	1.50
Floor	1.50	1.50	1.50	Agitator for pure liquors	1.25	1.25	1.25
Green	1.50	1.50	1.75	Barking drums	2.00	2.00	2.00
Cut-off saws				Barkers -mechanical	2.00	2.00	2.00
Chain	1.50	1.50	1.75	Beater	1.50	1.50	1.50
Drag	1.50	1.50	1.75	Breaker stack	1.25	1.25	1.25
Debarking drums	1.75	1.75	2.00	Calendar	1.25	1.25	1.25
Feeds				Chipper	2.00	2.00	2.00
Edger	1.25	1.25	1.50	Chip feeder	1.50	1.50	1.50
Gang	1.75	1.75	1.75	Coating rolls	1.25	1.25	1.25
Trimmer	1.25	1.25	1.50	Conveyors			
Log deck	1.75	1.75	1.75	Chip, bark, chemical	1.25	1.25	1.25
Log hauls - incline - well type	1.75	1.75	1.75	Log (including slab)	2.00	2.00	2.00
Log turning devices	1.75	1.75	1.75	Couch rolls	1.25	1.25	1.25
Planer feed	1.25	1.25	1.50	Cutter	2.00	2.00	2.00
Planer tilting hoists	1.50	1.50	1.50	Cylinder moulds	1.25	1.25	1.25
Rolls -live-off bearings - roll cases	1.75	1.75	1.75	Dryers			
Sorting table	1.25	1.25	1.50	Paper machine	1.25	1.25	1.25
Tipple hoist	1.25	1.25	1.50	Conveyor type	1.25	1.25	1.25
Transfers				Embosses	1.25	1.25	1.25
Chain	1.50	1.50	1.75	Extruder	1.50	1.50	1.50
Crane way	1.50	1.50	1.75	Fourdrinier rolls (includes lump breaker, dandy roll, wire turning, and return rolls)	1.25	1.25	1.25
Tray drives	1.25	1.25	1.50	Jordan	1.50	1.50	1.50
Veneer lathe drives	1.25	1.25	1.50	Kiln drive	1.50	1.25	1.50
Metal mills				Mt Hope roll	1.25	1.50	1.25
Draw bench carriage and main drive	1.25	1.25	1.50	Paper rolls	1.25	1.25	1.25
Runout table				Platter	1.50	1.50	1.50
Non-reversing				Presses - felt and suction	1.25	1.25	1.25
Group drives	1.50	1.50	1.50	Pulper	2.00	2.00	2.00
Individual drives	2.00	2.00	2.00	Pumps - vacuum	1.50	1.50	1.50
Reversing	2.00	2.00	2.00	Reel (surface type)	1.25	1.25	1.25
Slab pushers	1.50	1.50	1.50	Screens			
Shears	2.00	2.00	2.00	Chip	1.50	1.50	1.50
Wire drawing machine	1.25	1.25	1.50	Rotary	1.50	1.50	1.50
Wire winding machine	1.25	1.50	1.50	Vibrating	2.00	2.00	2.00
Metal strip processing machinery				Size press	1.25	1.25	1.25
Bridles	1.25	1.25	1.50	Super calendar	1.25	1.25	1.25
Coilers and uncoilers	1.00	1.00	1.25	Thickener (AC motor)	1.50	1.50	1.50
Edge trimmers	1.00	1.25	1.50	(DC motor)	1.25	1.25	1.25
Flatteners	1.25	1.25	1.50	Washer (AC motor)	1.50	1.50	1.50
Loopers (accumulators)	1.00	1.00	1.25	(DC motor)	1.25	1.25	1.25
Pinch rolls	1.25	1.25	1.50	Wind and unwind stand	1.00	1.00	1.25
Scrap choppers	1.25	1.25	1.50	Winders (surface type)	1.25	1.25	1.25
Shears	2.00	2.00	2.00	Yankee dryers	1.25	1.25	1.25
Slitters	1.00	1.25	1.50	Plastics industry			
Mills, rotary type				Primary processing			
Ball and rod	2.00	2.00	2.00	Intensive internal mixers			
Spur ring gear	2.00	2.00	2.00	Batch mixers	1.75	1.75	1.75
Helical ring gear	1.50	1.50	1.50	Continuous mixers	1.50	1.50	1.50
Direct connected	2.00	2.00	2.00	Batch drop mill - two smooth rolls	1.25	1.25	1.25
Cement kilns	1.50	1.50	1.50	Continuous feed, holding and blend mill	1.25	1.25	1.50
Dryers and coolers	1.50	1.50	1.50	Compounding mill	1.25	1.25	1.25
				Calendars	1.50	1.50	1.25

RS-RT Worm Gearboxes

Service factors

Application	Load duration (hrs/day)			Application	Load duration (hrs/day)		
	3 -	3 - 10	10 +		3 -	3 - 10	10 +
Plastics industry				Sand miller	1.25	1.25	1.50
Secondary processing				Sewage disposal equipment			
Blow moulders	1.50	1.50	1.50	Bar screens	1.25	1.25	1.25
Coating	1.25	1.25	1.25	Chemical feeders	1.25	1.25	1.25
Film	1.25	1.25	1.25	Dewatering screens	1.50	1.50	1.50
Pipe	1.25	1.25	1.25	Scum breakers	1.50	1.50	1.50
Pre-plasticizers	1.50	1.50	1.50	Slow or rapid mixers	1.50	1.50	1.50
Rods	1.25	1.25	1.25	Sludge collectors	1.25	1.25	1.25
Sheet	1.25	1.25	1.25	Thickeners	1.50	1.50	1.50
Tubing	1.25	1.25	1.50	Vacuum filters	1.50	1.50	1.50
Pullers -barge haul	1.25	1.25	1.50	Screens			
Pumps				Air washing	1.00	1.00	1.25
Centrifugal	1.00	1.00	1.25	Rotary - stone or gravel	1.25	1.25	1.50
Proportioning	1.25	1.25	1.00	Travelling water intake	1.00	1.00	1.25
Reciprocating				Sugar industry			
Single acting,	1.25	1.25	1.50	Beet slicer	2.00	2.00	2.00
three or more cylinders				Cane knives	1.50	1.50	1.50
Double acting,	1.25	1.25	1.50	Crushers	1.50	1.50	1.50
two or more cylinders				Mills (low speed end)	1.75	1.75	1.75
Rotary				Textile industry			
Gear type	1.00	1.00	1.25	Batchers	1.25	1.25	1.50
Lobe	1.00	1.00	1.25	Calendars	1.25	1.25	1.50
Vane	1.00	1.00	1.25	Cards	1.25	1.25	1.50
Rubber industry				Dry cans	1.25	1.25	1.50
Intensive internal mixers				Dryers	1.25	1.25	1.50
Batch mixers	1.75	1.75	1.75	Dyeing machinery	1.25	1.25	1.50
Continuous mixers	1.50	1.50	1.50	Looms	1.25	1.25	1.50
Mixing mill - two smooth rolls (if cor- rugated rolls are used, then use the same selection factors that are used for a cracker warmer).	1.50	1.50	1.50	Mangles	1.25	1.25	1.50
Batch drop mill - two smooth rolls	1.50	1.50	1.50	Nappers	1.25	1.25	1.50
Cracker warmer - two rolls; one corrugated roll	1.75	1.75	1.75	Pads	1.25	1.25	1.50
Cracker - two corrugated rolls.				Slashers	1.25	1.25	1.50
Holding, feed and blend mill - two rolls	2.00	2.00	2.00	Soapers	1.25	1.25	1.50
Refiner - two rolls	1.25	1.25	1.25	Spinners	1.25	1.25	1.50
Calendars	1.50	1.50	1.50	Tenter frames	1.25	1.25	1.50
	1.50	1.50	1.50	Washers	1.25	1.25	1.50
				Winders	1.25	1.25	1.50

This application guide is given by way of an example and therefore, may not include all the possible cases.

Should the application not be referable to any of the listed cases, the table below gives two service factors - F_1 referred to load type and work duration, and F_2 to starts and stops number of the duty cycle - of which the product is the needed gearbox oversizing coefficient in order to have a torque good enough to perform the required work.

Application: Conveyor 1000 in-lb @ 84 rpm - uniform load - 24 hrs/day is $F_1=1.4$; 6 start/stops per hour is $F_2=1.0$;

Required torque $1000 \times 1.4 \times 1.0 = 1400$ in-lb

Gearbox to select FRT70 1/20 (90 rpm) 1717 in-lb, i.e. the gearbox size with torque greater than 1400 in-lb

Gearbox service factor: $SF1.7 = 1717$ in-lb : 1000 in-lb

SERVICE FACTOR

$$SF = F_1 \times F_2$$

F_1 = Load & Operation factor

F_2 = Start/stop factor

	F_1	Uniform load	Variable load	Shock load	Start/stops per hour	F_2
	8 hrs	0.8	1.0	1.5	6	1.0
	16 hrs	1.0	1.2	1.8	60	1.2
	24 hrs	1.4	1.6	2.0	120	1.4

Worm Gearboxes - Series RS - RT

Weights - Oil quantity - Input loads

WEIGHTS [lb] & LUBRICANTS [US quarters / litres]										
RS - RT	Weight lb	Oil US qt	Oil litres	RA - TA	Weight lb	Oil US qt	Oil litres	RS / RS RT / RT	Weight lb	Oil US qt
28	2.43	0.03	0.03	63/40	8.82	0.04/0.08	0.04/0.08	28/28	5.51	0.06
40	5.51	0.08	0.08	63/50	11.68	0.04/0.14	0.04/0.13	28/40	8.60	0.11
50	8.38	0.14	0.13	63/60	17.64	0.04/0.26	0.04/0.25	28/50	11.46	0.17
60	14.33	0.26	0.25	71/50	14.55	0.06/0.14	0.06/0.13	28/60	17.42	0.29
70	19.84	0.37	0.35	71/60	20.50	0.06/0.25	0.06/0.25	40/70	26.46	0.45
85	29.76	0.63	0.60	71/70	26.01	0.06/0.37	0.06/0.35	40/85	36.38	0.71
110	85.98	1.59	1.50	71/85	35.93	0.06/0.63	0.06/0.60	50/110	99.21	1.73
130*	110.23	2.91	2.75	80/60	23.15	0.11/0.26	0.10/0.25	60/130*	125.66	3.17
150*	176.37	4.65	4.40	80/70	28.66	0.11/0.37	0.10/0.35	70/150*	198.41	5.02
				80/85	38.58	0.11/0.63	0.10/0.60			
				80/110	94.80	0.11/1.59	0.10/1.50			
				100/110	101.41	0.21/1.59	0.20/1.50			
				100/130*	141.09	0.21/2.91	0.20/2.75			
				100/150*	207.23	0.21/4.65	0.20/4.40			

(*) - RS sizes only

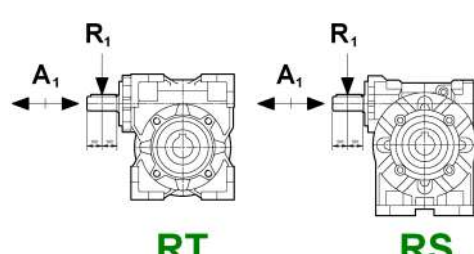
INPUT LOADS [lb]							
RPM	3300	1800	1100	900	600	350	
RS-RT 28	11	15	17	19	22	26	 <p>Overhung load - R_1 [lb] Axial Load - $A_1 = 0.2 \times R_1$ [lb]</p>
RS-RT 40	24	32	35	37	39	43	
RS-RT 50	32	43	48	54	61	65	
RS-RT 60	50	65	71	76	80	87	
RS-RT 70	56	76	87	95	102	108	
RS-RT 85	74	97	112	125	134	151	
RS-RT 110	123	162	173	184	199	216	
RS 130	151	216	227	238	249	260	
RS 150	195	260	270	281	303	324	

RS-RT Worm Gearboxes

Output Loads

OUTPUT LOADS [lb]

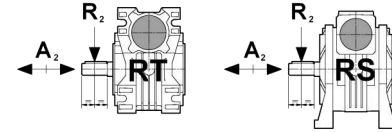

$$A_2 = 0.2 \times R_2$$

STANDARD OUTPUT SHAFT BEARINGS

- OHL Overhung load R_2 [lb]

- Axial load $A_2 = 0.2 \times R_2$ [lb]

R	5	7	10	15	20	28	40	49	56	70	80	100	Bearing Type
rpm	336	240	168	112	84	60	42	35	30	24	22	17	
RS-RT28	108	97	108	119	130	134	151	162	173	195	205	216	16005
RS-RT40	216	216	238	260	292	324	346	368	389	411	433	497	16006
RS-RT50	314	270	314	368	411	433	497	519	562	606	627	692	16008
RS-RT60	487	519	541	627	714	779	843	930	995	1081	1146	1211	①
RS-RT70	562	584	627	779	843	908	973	1125	1189	1276	1363	1449	②
RS-RT85	714	714	800	952	1016	1168	1189	1363	1427	1536	1622	1795	③
RS-RT110	---	843	898	1125	1168	1276	1233	1622	1687	1730	1903	2119	④
RS130	---	1081	1265	1330	1406	1427	1687	1903	2055	2098	2271	2487	6015
RS150	---	1406	1665	1795	1903	1946	2379	2595	2703	2812	3028	3244	6216

① - RS: 6008 / RT: 6208

② - RS: 6009 / RT: 6209

③ - RS: 6010 / RT: 6210

④ - RS: 6012 / RT: 6212

HEAVY DUTY OUTPUT SHAFT BEARINGS

- OHL Overhung load R_2 [lb]

- Axial load $A_2 = 0.2 \times R_2$ [lb]

R	5	7	10	15	20	28	40	49	56	70	80	100	Bearing Type
rpm	336	240	168	112	84	60	42	35	30	24	22	17	
RS-RT28	162	141	162	177	195	201	227	242	260	281	281	281	6005
RS-RT40	303	324	335	357	411	454	487	519	541	562	562	562	32006
RS-RT50	433	378	433	519	562	649	735	779	843	908	908	908	32008
RS-RT60	627	649	692	800	908	1038	1103	1233	1319	1427	1427	1427	30208
RS-RT70	725	714	800	973	1116	1211	1319	1492	1579	1709	1709	1709	⑤
RS-RT85	887	908	995	1189	1363	1557	1579	1817	1882	2033	2033	2033	⑥
RS-RT110	---	1081	1168	1449	1622	1730	2011	2271	2401	2401	2401	2401	⑦
RS130	---	1514	1709	1860	2098	2141	2530	2790	3071	3136	3136	3136	32015
RS150	---	1946	2336	2509	2855	2920	3568	3893	4044	4217	4217	4217	30216

⑤ - RS: 32009 / RT: 30209

⑥ - RS: 32010 / RT: 30210

⑦ - RS: 32012 / RT: 30212

Worm Gearboxes - Series RS - RT

Output loads

OUTPUT RADIAL LOADS

OUTPUT RADIAL LOADS (OHL)

Overhung (radial) loads (F_r) should be checked according to output speed, mounting position (A) and type of the transmission element (B) fitted on the gearbox output shaft and rectified when applicable by the appropriate k_T rating factor.

Application point of radial load

OHL is considered as applied at the output shaft mid-point.

Other positions origin loads to be adjusted with the appropriate factor k_L .

Examples of load distance from the shaft shoulder:

k_L	L
1.1	1/4 * L
1.0	1/2 * L
0.9	3/4 * L
0.8	L

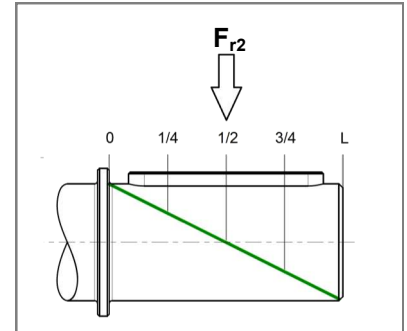

Transmission element

k_T	Type of transmission element
1,15	Gear tooth No. < 17
1,40	Chain sprocket tooth No. < 13
1,25	tooth No. < 20
1,00	tooth No. > 20
2,50	Pulley for V-belt
1,25	toothed-belt

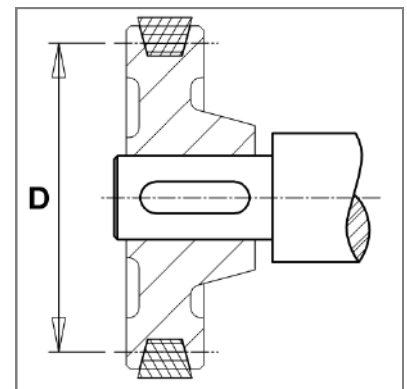

Overhung (radial) load - F_{r2}

$$F_{r2} = \frac{2000 * M_2}{D} \times k_L \times k_T$$

OUTPUT AXIAL LOADS

Axial load - F_{a2}

$$F_{a2} = F_{r2} \times 0.2$$

Axial load value is included within the catalogue radial load figures and is valid on both tensile and compressive stress.

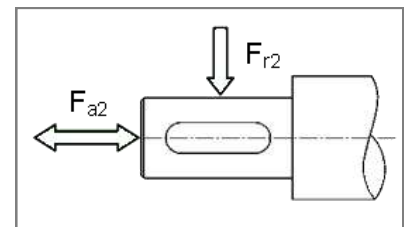

RS-RT Worm Gearboxes

RS-RT Selection

Single stage

2-poles - SF1.0

3600 rpm	Ratio	5	7	10	15	20	28	40	49	56	70	80	100
	output rpm	720	514	360	240	180	129	90	73	64	51	45	36
RS - RT 28 1.10" CD	HP	1.35	1.06	0.82	0.59	0.42	0.39	0.27	0.22	0.20	0.15	0.13	0.07
	in-lb	115	115	124	124	115	133	124	115	106	97	89	62
	eff.	0.86	0.86	0.83	0.79	0.77	0.69	0.64	0.61	0.54	0.49	0.49	0.46
RS - RT 40 1.57" CD	HP	3.52	2.51	2.01	1.37	0.94	0.82	0.60	0.50	0.44	0.35	0.32	0.25
	in-lb	283	274	301	301	266	301	283	274	266	257	248	230
	eff.	0.89	0.87	0.85	0.81	0.78	0.72	0.66	0.62	0.6	0.57	0.54	0.51
RS - RT 50 1.97" CD	HP	1.49	1.46	1.42	1.36	1.31	1.21	1.11	1.04	1.01	0.96	0.91	0.85
	in-lb	513	549	522	540	460	584	522	496	469	407	434	354
	eff.	0.9	0.88	0.86	0.82	0.8	0.75	0.69	0.66	0.64	0.58	0.58	0.52
RS - RT 60 2.36" CD	HP	9.72	7.38	5.87	4.36	3.18	2.68	1.84	1.21	1.22	1.01	0.87	0.57
	in-lb	797	823	920	974	956	1027	929	752	814	814	752	602
	eff.	0.9	0.88	0.87	0.84	0.82	0.76	0.73	0.71	0.66	0.64	0.6	0.58
RS - RT 70 2.76" CD	HP	13.58	9.55	7.21	5.36	4.02	3.69	2.51	2.01	1.68	1.34	1.16	0.91
	in-lb	1115	1080	1151	1230	1204	1425	1372	1257	1151	1062	1018	947
	eff.	0.91	0.89	0.88	0.85	0.83	0.78	0.74	0.7	0.68	0.63	0.61	0.58
RS - RT 85 3.35" CD	HP	21.79	16.09	12.57	8.88	7.21	5.20	4.02	3.35	2.85	2.18	1.84	1.56
	in-lb	1788	1814	1991	2071	2097	2080	2213	2142	2027	1859	1770	1682
	eff.	0.91	0.89	0.88	0.86	0.8	0.8	0.76	0.72	0.71	0.67	0.64	0.6
RS - RT 110 4.33" CD	HP	---	29.33	24.81	17.94	14.42	11.73	8.38	7.54	6.03	5.20	5.03	3.52
	in-lb	---	3319	3938	4160	4337	4691	4602	4823	4337	4646	4779	3983
	eff.	---	0.9	0.88	0.86	0.84	0.79	0.76	0.73	0.71	0.7	0.67	0.62
RS 130 5.12" CD	HP	---	44.09	36.21	26.48	20.45	15.76	12.91	10.06	8.88	6.54	5.53	4.02
	in-lb	---	5000	5797	6239	6328	6328	7213	6549	6903	5930	5487	4956
	eff.	---	0.9	0.89	0.87	0.86	0.8	0.78	0.74	0.77	0.72	0.68	0.68
RS 150 5.91" CD	HP	---	62.02	49.62	38.22	28.66	22.80	17.94	14.25	11.06	9.22	8.21	6.03
	in-lb	---	7036	7965	8983	8894	9425	10355	9647	8585	8408	8098	7478
	eff.	---	0.9	0.89	0.87	0.86	0.82	0.8	0.77	0.77	0.72	0.68	0.68

Worm Gearboxes - Series RS - RT

SF1.0 - 4 poles

Single stage

RS-RT Selection

1800 rpm	Ratio	5	7	10	15	20	28	40	49	56	70	80	100
	output rpm	360	257	180	120	90	64	45	37	32	26	23	18
RS - RT 28 1.10" CD	HP	1.09	0.75	0.55	0.39	0.27	0.27	0.17	0.15	0.13	0.10	0.08	0.05
	in-lb	159	159	159	159	142	177	150	150	133	106	106	71
	eff.	0.84	0.84	0.81	0.77	0.74	0.66	0.62	0.57	0.51	0.45	0.45	0.43
RS - RT 40 1.57" CD	HP	1.87	1.84	1.36	0.92	0.64	0.62	0.42	0.35	0.30	0.23	0.20	0.15
	in-lb	398	398	407	389	345	425	372	363	336	319	283	257
	eff.	0.87	0.85	0.83	0.78	0.75	0.68	0.61	0.58	0.56	0.52	0.50	0.46
RS - RT 50 1.97" CD	HP	4.53	3.02	2.18	1.56	1.06	1.06	0.69	0.62	0.52	0.42	0.34	0.22
	in-lb	717	664	664	655	575	752	637	673	628	558	513	381
	eff.	0.88	0.86	0.84	0.78	0.76	0.71	0.64	0.62	0.60	0.53	0.52	0.47
RS - RT 60 2.36" CD	HP	6.87	4.69	3.86	2.68	2.01	1.68	1.26	1.04	0.91	0.77	0.62	0.42
	in-lb	1106	1000	1177	1151	1080	1230	1195	1133	1089	1080	938	735
	eff.	0.89	0.86	0.84	0.81	0.77	0.71	0.66	0.62	0.60	0.55	0.53	0.49
RS - RT 70 2.76" CD	HP	9.55	6.71	5.20	3.69	3.02	2.51	2.01	1.41	1.24	0.97	0.84	0.62
	in-lb	1558	1469	1593	1664	1717	1912	2106	1673	1593	1443	1363	1151
	eff.	0.89	0.88	0.86	0.83	0.81	0.75	0.71	0.67	0.64	0.59	0.56	0.52
RS - RT 85 3.35" CD	HP	15.25	10.39	7.71	5.70	4.86	3.69	2.68	2.35	2.01	1.61	1.44	0.92
	in-lb	2469	2292	2372	2558	2850	2823	2876	2797	2699	2567	2478	1859
	eff.	0.90	0.88	0.86	0.83	0.82	0.76	0.72	0.67	0.68	0.63	0.60	0.56
RS - RT 110 4.33" CD	HP	---	20.95	15.09	10.90	9.55	7.38	5.87	4.53	3.69	3.35	2.51	1.84
	in-lb	---	4646	4708	4956	5726	5682	6115	5584	5266	5620	4646	4151
	eff.	---	0.88	0.87	0.84	0.83	0.76	0.73	0.71	0.70	0.67	0.66	0.61
RS 130 5.12" CD	HP	---	31.85	25.14	18.44	14.25	12.57	9.22	6.54	6.20	4.53	4.02	3.02
	in-lb	---	7142	7877	8496	8629	9735	10089	8408	8894	7655	7169	6638
	eff.	---	0.89	0.87	0.85	0.84	0.77	0.76	0.72	0.71	0.67	0.63	0.61
RS 150 5.91" CD	HP	---	41.74	35.20	26.82	20.95	15.92	13.41	9.89	8.55	6.37	5.53	4.36
	in-lb	---	9381	11151	12479	12656	12700	14868	12744	12567	10886	10355	9912
	eff.	---	0.89	0.88	0.86	0.84	0.79	0.77	0.73	0.73	0.68	0.65	0.63

RS-RT Worm Gearboxes

RS-RT Selection

Single stage

6 poles - SF1.0

1200 rpm	Ratio	5	7	10	15	20	28	40	49	56	70	80	100
	output rpm	240	171	120	80	60	43	30	24	21	17	15	12
RS - RT 28 1.10" CD	HP	0.79	0.60	0.40	0.30	0.22	0.20	0.13	0.12	0.10	0.07	0.05	0.03
	in-lb	195	195	177	186	168	195	177	168	142	115	97	71
	eff.	0.82	0.82	0.78	0.72	0.7	0.61	0.56	0.52	0.45	0.43	0.4	0.37
RS - RT 40 1.57" CD	HP	2.01	1.41	1.07	0.74	0.50	0.47	0.32	0.27	0.23	0.20	0.17	0.13
	in-lb	478	460	478	460	398	460	407	381	363	354	345	319
	eff.	0.86	0.83	0.8	0.74	0.7	0.63	0.56	0.52	0.49	0.46	0.44	0.42
RS - RT 50 1.97" CD	HP	3.52	2.51	1.84	1.26	0.87	0.85	0.59	0.47	0.42	0.32	0.28	0.20
	in-lb	850	841	841	805	699	876	752	717	708	593	593	487
	eff.	0.86	0.85	0.81	0.76	0.72	0.65	0.58	0.56	0.54	0.47	0.46	0.42
RS - RT 60 2.36" CD	HP	5.36	4.02	3.18	2.35	1.68	1.46	0.94	0.72	0.67	0.54	0.47	0.32
	in-lb	1328	1328	1443	1469	1425	1549	1345	1195	1151	1106	1018	832
	eff.	0.87	0.85	0.83	0.75	0.76	0.68	0.64	0.61	0.55	0.53	0.48	0.47
RS - RT 70 2.76" CD	HP	7.54	5.36	4.02	2.85	2.18	2.01	1.46	1.07	0.89	0.70	0.64	0.50
	in-lb	1876	1788	1867	1929	1832	2142	2124	1814	1655	1505	1416	1301
	eff.	0.88	0.86	0.83	0.79	0.77	0.7	0.654	0.62	0.59	0.54	0.5	0.46
RS - RT 85 3.35" CD	HP	12.07	8.38	6.54	5.03	3.52	3.02	2.51	1.68	1.39	1.22	1.07	0.85
	in-lb	2991	2832	3098	3345	3142	3301	3629	3098	2938	2655	2567	2301
	eff.	0.88	0.86	0.84	0.8	0.78	0.71	0.66	0.672	0.671	0.55	0.53	0.48
RS - RT 110 4.33" CD	HP	---	16.43	13.41	9.55	7.38	6.20	4.53	3.86	3.18	2.85	2.51	1.58
	in-lb	---	5620	6372	6593	6593	7036	6903	6903	6107	6770	6328	4425
	eff.	---	0.87	0.85	0.82	0.79	0.73	0.68	0.64	0.62	0.59	0.57	0.5
RS 130 5.12" CD	HP	---	24.98	19.61	14.08	10.90	8.55	6.87	5.20	4.69	3.52	3.02	2.18
	in-lb	---	8629	9470	9868	9868	10133	10753	9691	10133	8496	7877	7124
	eff.	---	0.88	0.86	0.83	0.81	0.75	0.7	0.67	0.68	0.63	0.58	0.57
RS 150 5.91" CD	HP	---	34.87	26.65	20.45	15.59	12.24	9.39	7.54	5.53	4.86	4.19	3.35
	in-lb	---	12036	13010	14470	14381	14691	15399	14160	12125	12302	11417	10886
	eff.	---	0.88	0.87	0.84	0.82	0.77	0.73	0.69	0.69	0.64	0.61	0.58

Worm Gearboxes - Series RS - RT

SF1.0 - 8 poles

Single stage

RS-RT Selection

900 rpm	Ratio	5	7	10	15	20	28	40	49	56	70	80	100
	output rpm	180	129	90	60	45	32	23	18	16	13	11	9
RS - RT 28 1.10" CD	HP	0.66	0.49	0.35	0.23	0.17	0.17	0.10	0.08	0.07	0.05	0.03	0.02
	in-lb	204	204	204	195	186	212	186	177	150	115	97	71
	eff.	0.81	0.81	0.77	0.71	0.69	0.6	0.55	0.51	0.44	0.4	0.39	0.36
RS - RT 40 1.57" CD	HP	1.68	1.24	0.91	0.65	0.44	0.40	0.28	0.23	0.20	0.17	0.15	0.12
	in-lb	522	513	513	513	434	487	434	407	398	381	363	336
	eff.	0.85	0.82	0.79	0.73	0.68	0.59	0.53	0.5	0.48	0.44	0.42	0.39
RS - RT 50 1.97" CD	HP	3.02	2.35	1.54	1.09	0.74	0.72	0.49	0.40	0.35	0.27	0.25	0.20
	in-lb	938	974	885	876	761	938	805	770	735	620	637	549
	eff.	0.86	0.83	0.8	0.75	0.71	0.64	0.57	0.542	0.52	0.45	0.44	0.39
RS - RT 60 2.36" CD	HP	4.69	3.35	2.68	1.84	1.46	1.22	0.82	0.59	0.57	0.44	0.40	0.28
	in-lb	1460	1451	1566	1575	1549	1655	1460	1239	1230	1133	1062	885
	eff.	0.87	0.84	0.81	0.77	0.74	0.67	0.62	0.59	0.54	0.51	0.46	0.44
RS - RT 70 2.76" CD	HP	6.54	4.53	3.52	2.35	1.84	1.68	1.19	0.92	0.77	0.60	0.54	0.40
	in-lb	2071	1912	2062	2044	1991	2266	2168	1947	1743	1558	1478	1328
	eff.	0.87	0.85	0.82	0.78	0.75	0.68	0.63	0.6	0.56	0.51	0.48	0.45
RS - RT 85 3.35" CD	HP	10.39	7.71	5.87	4.19	3.18	2.51	2.01	1.56	1.31	0.99	0.94	0.74
	in-lb	3292	3275	3540	3611	3434	3540	3717	3354	3124	2744	2699	2434
	eff.	0.87	0.85	0.83	0.79	0.76	0.69	0.65	0.61	0.59	0.55	0.5	0.46
RS - RT 110 4.33" CD	HP	---	14.25	11.40	8.21	6.54	5.53	3.86	3.35	2.85	2.51	2.01	1.32
	in-lb	---	6195	6903	7036	7213	7877	7257	7434	6815	7213	6372	4558
	eff.	---	0.86	0.84	0.8	0.77	0.71	0.66	0.62	0.6	0.57	0.55	0.48
RS 130 5.12" CD	HP	---	21.46	17.27	12.40	9.39	7.38	6.03	4.53	4.02	3.02	2.68	1.84
	in-lb	---	9381	10620	10886	10753	10620	11682	10487	10753	9116	8452	7567
	eff.	---	0.87	0.85	0.81	0.8	0.72	0.68	0.65	0.66	0.61	0.56	0.55
RS 150 5.91" CD	HP	---	30.17	22.96	17.77	13.58	10.39	8.21	6.37	5.03	4.36	3.86	2.85
	in-lb	---	13054	14249	15974	15753	15842	16727	15134	13585	13275	12611	11284
	eff.	---	0.87	0.86	0.83	0.81	0.75	0.71	0.68	0.67	0.61	0.58	0.56

RS-RT Worm Gearboxes

RA-TA Selection

Helical/worm - 3.5:1

4 poles - SF1.0

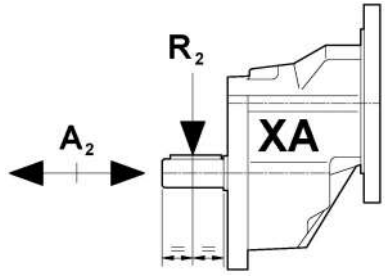
XA	i_n rpm	3.5	6.3	8	XA - Single-stage helical attachment FXA63, FXA71 & FXA80: IEC input only FXA100: NEMA and IEC input 				
		514	286	225					
XA63	i_r	3.5	6.2	7.8					
	HP	0.84	0.39	0.30					
	in-lb	106	89	80					
XA71	R_2 [lb]	8435	9732	9732					
	i_r	3.5	6.4	8.0					
	HP	1.84	0.87	0.62					
XA80	in-lb	230	195	177					
	R_2 [lb]	10597	12111	12111					
	i_r	3.4	6.4	8.3					
XA100	HP	5.20	2.51	1.84					
	in-lb	602	575	531					
	R_2 [lb]	13193	15139	15139					
XA100	i_r	3.9	6.2	7.5	R_2 [lb] = Input Overhung Load (OHL) A_2 (0.2 x R_2) [lb] = Output Axial Load i_n = nominal reduction ratio i_r = real reduction ratio				
	HP	14.58	6.71	3.69					
	in-lb	2080	1443	1204					
	R_2 [lb]	44979	31198	26030					

Helical/worm gearbox RA - TA

R_1 3.5:1	$R_1 \times R_2$	18	25	35	53	70	98	140	172	196	245	280	350	
		R_2	5	7	10	15	20	28	40	49	56	70	80	100
		rpm	100	72	51	34	26	18	13	10	9	7	6	5
RA - TA 63/40	HP	0.94	0.92	0.67	0.47	0.34	0.32	0.22	0.18	0.17	0.10	0.08	0.05	
	in-lb	0.37	637	637	620	531	620	566	513	496	372	310	221	
	eff.	0.80	0.78	0.75	0.7	0.63	0.56	0.5	0.46	0.44	0.41	0.4	0.35	
RA - TA 63/50 71/50	HP	1.37	1.71	1.17	0.84	0.55	0.54	0.35	0.34	0.27	0.18	0.15	0.10	
	in-lb	1270	1195	1124	1106	929	1106	929	1018	885	708	620	443	
	eff.	0.81	0.79	0.76	0.7	0.66	0.59	0.52	0.5	0.46	0.42	0.4	0.35	
RA - TA 63/60 71/60 80/60	HP	2.70	2.56	1.98	1.39	0.96	0.89	0.55	0.45	0.39	0.32	0.25	0.17	
	in-lb	1940	1814	1920	1903	1699	1920	1566	1505	1345	1283	974	752	
	eff.	0.82	0.8	0.77	0.72	0.7	0.61	0.57	0.54	0.49	0.45	0.38	0.36	
RA - TA 71/70 80/70	HP	3.57	3.29	2.48	1.81	1.29	1.21	0.84	0.72	0.60	0.50	0.44	0.32	
	in-lb	2500	2345	2434	2522	2301	2744	2390	2390	2080	1991	1770	1593	
	eff.	0.83	0.81	0.78	0.74	0.71	0.64	0.57	0.54	0.49	0.45	0.41	0.39	
RA - TA 71/85 80/85	HP	5.5	5.26	4.01	2.97	2.30	1.86	1.34	1.09	0.97	0.82	0.67	0.44	
	in-lb	3900	3806	3983	4204	4160	4204	3938	3717	3629	3452	3009	2213	
	eff.	0.84	0.82	0.79	0.75	0.72	0.64	0.58	0.55	0.53	0.48	0.44	0.4	
RA - TA 80/110 100/110	HP	---	10.09	7.76	6.00	4.38	3.65	2.68	2.13	1.88	1.44	1.44	0.91	
	in-lb	---	7390	7921	8408	8054	8496	8408	7523	7257	6638	6549	4779	
	eff.	---	0.83	0.81	0.74	0.73	0.66	0.62	0.57	0.55	0.52	0.45	0.42	
RA 100/130	HP	---	11.73	11.40	9.22	6.37	5.20	3.86	2.85	2.51	2.18	1.84	1.34	
	in-lb	---	8629	11682	13231	11948	12656	12213	11505	11063	10620	9558	7788	
	eff.	---	0.83	0.81	0.77	0.75	0.67	0.63	0.64	0.62	0.6	0.5	0.48	
RA 100/150	HP	---	13.24	13.07	12.57	9.55	7.54	5.53	4.53	4.02	3.02	2.68	1.68	
	in-lb	---	11415	13585	18497	18231	18851	18143	18054	17921	15045	12912	10620	
	eff.	---	0.84	0.82	0.79	0.76	0.69	0.66	0.64	0.62	0.6	0.52	0.5	

Worm Gearboxes - Series RS - RT

SF1.0 - 4 poles

Helical/worm - 6.3:1

RA-TA Selection

R₁ 6.3:1	R ₁ xR ₂	32	44	63	95	126	176	252	309	353	441	504	630
	R ₂	5	7	10	15	20	28	40	49	56	70	80	100
	rpm	56	41	29	19	14	10	7	6	5	4	4	3
RA - TA 63/40	HP	0.60	0,59	0,42	0,28	0,20	0,18	0,13	0,10	0,10	0,08	0,07	0,05
	in-lb	699	699	690	655	558	611	558	504	487	469	451	407
	eff.	0.78	0,76	0,72	0,67	0,6	0,52	0,45	0,43	0,39	0,35	0,34	0,31
RA - TA 63/50 71/50	HP	1.09	1,04	0,70	0,50	0,34	0,34	0,23	0,18	0,17	0,15	0,12	0,08
	in-lb	1320	1283	1177	1151	1000	1221	1018	956	885	814	788	637
	eff.	0.80	0,78	0,74	0,67	0,63	0,55	0,48	0,45	0,42	0,36	0,36	0,31
RA - TA 63/60 71/60 80/60	HP	1.63	1,54	1,24	0,87	0,67	0,59	0,39	0,27	0,27	0,18	0,17	0,13
	in-lb	1980	1929	2097	2080	2036	2106	1859	1416	1549	1248	1151	1080
	eff.	0.81	0,79	0,75	0,7	0,67	0,57	0,53	0,49	0,45	0,42	0,37	0,35
RA - TA 71/70 80/70	HP	2.08	2,01	1,59	1,14	0,84	0,74	0,54	0,44	0,39	0,30	0,28	0,20
	in-lb	2600	2558	2744	2744	2584	2832	2292	2407	2248	1956	1859	1682
	eff.	0.82	0,8	0,76	0,71	0,68	0,6	0,54	0,5	0,46	0,42	0,37	0,36
RA - TA 71/85 80/85	HP	3.48	3,35	2,68	1,84	1,41	1,16	0,89	0,72	0,62	0,47	0,44	0,37
	in-lb	4400	4337	4655	4567	4381	4434	4425	4124	3974	3460	3363	3053
	eff.	0.82	0,8	0,77	0,72	0,69	0,6	0,55	0,51	0,5	0,46	0,42	0,36
RA - TA 80/110 100/110	HP	---	7,21	5,36	4,02	3,02	2,68	1,84	1,68	1,34	1,11	0,85	0,54
	in-lb	---	9116	9735	10178	9735	10355	9824	9735	8806	8408	6903	4868
	eff.	---	0,81	0,79	0,74	0,71	0,63	0,57	0,53	0,52	0,48	0,45	0,39
RA 100/130	HP	---	10,74	8,28	6,24	4,54	3,97	2,77	2,46	2,10	1,71	1,37	0,79
	in-lb	---	14160	15045	15930	15045	15930	15045	15045	14160	14160	11505	7965
	eff.	---	0,83	0,8	0,75	0,73	0,63	0,6	0,55	0,53	0,52	0,46	0,45
RA 100/150	HP	---	14,10	11,08	8,45	6,32	5,06	3,87	3,05	2,36	2,08	1,83	1,41
	in-lb	---	18585	20355	22125	21240	21240	22125	20355	17700	15930	15930	15045
	eff.	---	0,83	0,81	0,77	0,74	0,66	0,63	0,6	0,59	0,81	0,48	0,47

RS-RT Worm Gearboxes

RA-TA Selection

Helical/worm - 8:1

4 poles - SF1.0

R ₁ 8:1	R ₁ ×R ₂	40	56	80	120	160	224	320	392	448	560	640	800
	R ₂	5	7	10	15	20	28	40	49	56	70	80	100
	rpm	45	32	23	15	11	8.0	6.6	4.6	4.0	3.2	2.8	2,2
RA - TA 63/40	HP	0.55	0.54	0.39	0.27	0.18	0.18	0.13	0.10	0.08	0.05	0.05	0.03
	in-lb	823	823	788	743	637	752	664	611	522	398	336	239
	eff.	0.71	0.75	0.72	0.65	0.59	0.5	0.44	0.41	0.38	0.36	0.34	0.31
RA - TA 63/50 71/50	HP	1.05	0.97	0.69	0.47	0.34	0.30	0.22	0.17	0.15	0.10	0.08	0.05
	in-lb	1620	1505	1460	1363	1151	1328	1151	1062	1018	761	646	469
	eff.	0.79	0.77	0.73	0.67	0.61	0.55	0.47	0.45	0.41	0.36	0.37	0.31
RA - TA 63/60 71/60 80/60	HP	1.6	1.46	1.14	0.82	0.57	0.52	0.35	0.27	0.25	0.17	0.13	0.08
	in-lb	2480	2301	2478	2434	2124	2390	2080	1947	1770	1372	1106	814
	eff.	0.80	0.78	0.75	0.69	0.65	0.57	0.51	0.5	0.43	0.41	0.37	0.35
RA - TA 71/70 80/70	HP	2.31	2.11	1.47	1.06	0.74	0.80	0.50	0.40	0.34	0.27	0.20	0.08
	in-lb	3560	3363	3230	3186	2876	3894	2832	2832	2434	2168	1770	1283
	eff.	0.81	0.79	0.76	0.7	0.67	0.6	0.53	0.5	0.45	0.41	0.38	0.35
RA - TA 71/85 80/85	HP	3.2	2.95	2.38	1.79	1.42	1.09	0.80	0.67	0.55	0.44	0.34	0.22
	in-lb	5050	4691	5266	5487	5487	5310	4956	4868	4514	3983	3186	2301
	eff.	0.81	0.79	0.77	0.71	0.67	0.6	0.54	0.52	0.5	0.45	0.41	0.37
RA - TA 80/110 100/110	HP	---	5.73	4.61	3.30	2.55	2.16	1.63	1.22	1.07	0.87	0.72	0.45
	in-lb	---	9248	10355	10443	10266	10620	10443	9027	8673	8142	7523	4868
	eff.	---	0.8	0.78	0.73	0.7	0.61	0.56	0.52	0.5	0.46	0.45	0.38
RA 100/130	HP	---	5.53	5.03	5.36	3.86	3.02	2.01	1.84	1.51	1.17	1.17	0.84
	in-lb	---	8850	10974	16284	15620	15576	15045	14691	14160	12700	11771	10266
	eff.	---	0.8	0.78	0.73	0.72	0.62	0.58	0.56	0.54	0.51	0.45	0.43
RA 100/150	HP	---	6.20	5.70	6.03	5.70	4.53	3.35	2.85	2.35	1.84	1.68	1.34
	in-lb	---	10001	12611	19028	22833	23674	25311	22568	22037	18674	17435	16417
	eff.	---	0.81	0.79	0.75	0.72	0.63	0.61	0.56	0.57	0.49	0.46	0.45

Worm Gearboxes - Series RS - RT

SF1.0 - 4 poles

Two-stage worm

RS/RS-RT/RT Selection

RS/RS RT/RT	R ₁	10	15	20	28	40	56	56	70	100	100	100	100
	R ₂	28	28	28	28	28	28	40	40	40	56	80	100
	R ₁ xR ₂	280	420	560	784	1120	1568	2240	2800	4000	5600	8000	10000
	rpm	6.4	4,3	3,2	2,3	1,6	1,2	0,80	0,64	0,45	0,32	0,23	0,18
28/28	HP	0.055	0.05	0.04	0.04	0.03	0.02	0.02	0.01	0.01	0.005	0.003	0.002
	in-lb	300	310	319	319	319	310	266	266	266	142	106	97
	eff.	0.40	0.38	0.37	0.32	0.3	0.25	0.21	0.20	0.18	0.14	0.12	0.13
28/40	HP	0.14	0.13	0.10	0.08	0.06	0.05	0.04	0.04	0.02	0.02	0.008	0.005
	in-lb	740	752	752	708	708	708	646	673	620	549	363	221
	eff.	0.42	0.39	0.37	0.33	0.31	0.25	0.21	0.18	0.18	0.15	0.14	0.12
28/50	HP	0.24	0.22	0.18	0.15	0.12	0.10	0.06	0.06	0.05	0.03	0.02	0.01
	in-lb	1300	1328	1328	1416	1549	1416	1106	1159	1301	1106	690	434
	eff.	0.42	0.39	0.37	0.33	0.31	0.25	0.22	0.19	0.19	0.16	0.14	0.12
28/60	HP	0.36	0.33	0.26	0.22	0.15	0.15	0.11	0.09	0.05	0.05	0.03	0.02
	in-lb	2050	2124	2124	2168	2036	2301	2168	1920	1451	1726	1133	805
	eff.	0.45	0.42	0.4	0.35	0.33	0.27	0.23	0.21	0.2	0.16	0.14	0.13
40/70	HP	0.55	0.50	0.42	0.33	0.26	0.20	0.14	0.12	0.10	0.07	0.04	0.03
	in-lb	3100	3363	3540	3540	3496	3363	3275	3053	3186	2841	1779	1363
	eff.	0.46	0.44	0.42	0.38	0.33	0.3	0.27	0.25	0.22	0.2	0.15	0.14
40/85	HP	0.8	0.75	0.62	0.46	0.38	0.30	0.23	0.20	0.15	0.12	0.07	0.04
	in-lb	5100	5266	5531	5177	5531	5399	5443	5266	5000	4868	3301	2336
	eff.	0.49	0.46	0.44	0.4	0.35	0.32	0.28	0.26	0.23	0.2	0.17	0.15
50/110	HP	1.6	1.45	1.27	0.97	0.76	0.64	0.49	0.39	0.27	0.21	0.14	0.09
	in-lb	10200	10532	11505	11505	11328	11948	11859	10709	9470	8673	7169	4956
	eff.	0.50	0.48	0.45	0.42	0.37	0.33	0.3	0.27	0.24	0.2	0.18	0.16
RS/RS only 60/130	HP	2.7	2.51	1.84	1.26	0.92	0.92	0.62	0.42	0.42	0.42	0.42	0.42
	in-lb	17100	17833	17081	14780	13541	17833	16196	12479	15665	16373	12567	10841
	eff.	0.53	0.5	0.46	0.43	0.4	0.35	0.33	0.3	0.27	0.25	0.21	0.2
RS/RS only 70/150	HP	3.3	3.02	2.51	1.84	1.26	1.26	0.92	0.62	0.62	0.42	0.42	0.42
	in-lb	27400	22745	25046	22745	21771	25223	26727	20576	25444	23630	18895	17656
	eff.	0.55	0.52	0.5	0.46	0.43	0.39	0.36	0.33	0.31	0.27	0.23	0.22

RS-RT Worm Gearboxes

Dimensions

RS

Single-stage worm

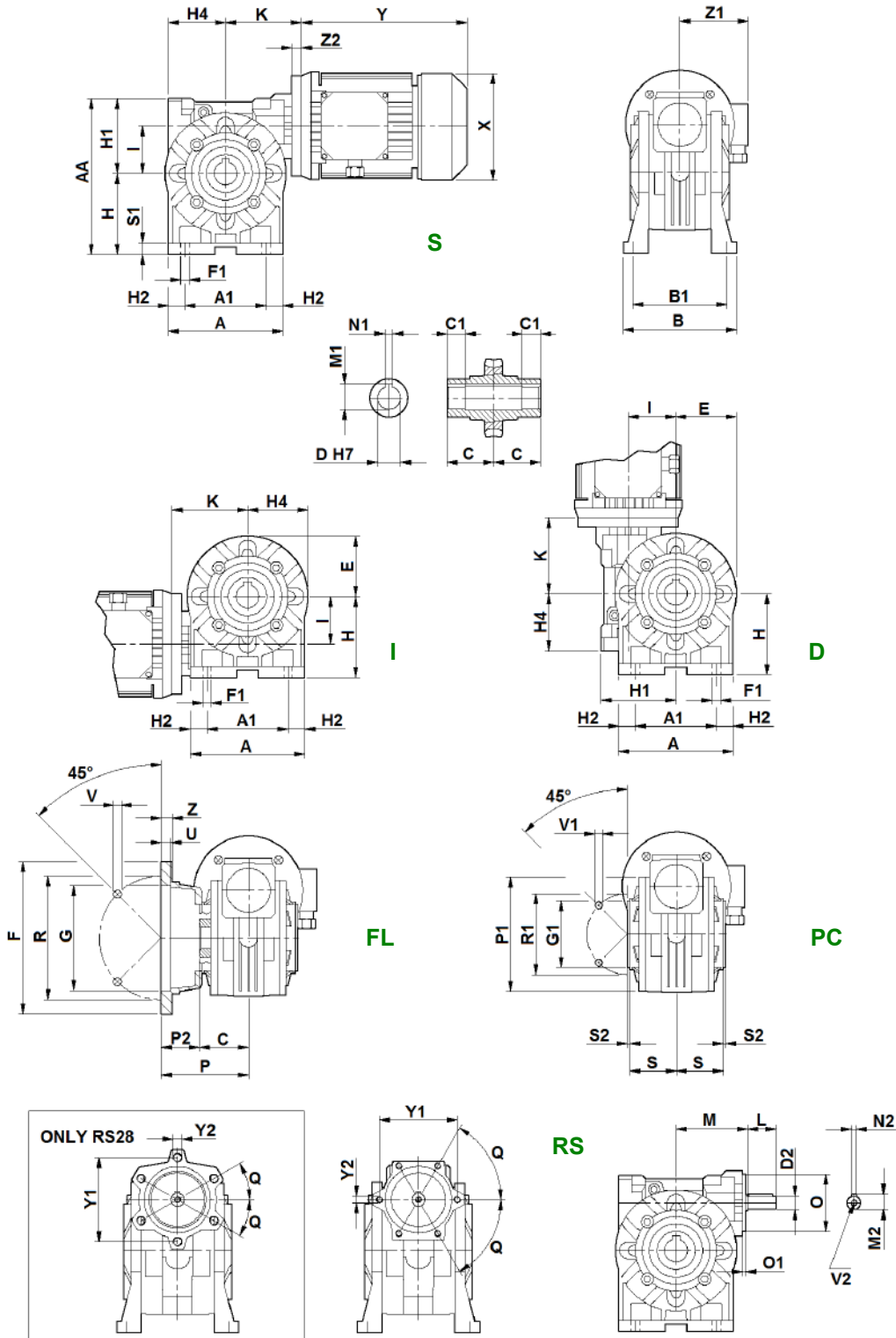

Worm Gearboxes - Series RS - RT

Single-stage worm

RS

Dimensions

RS (CD)	28 (1.10)	40 (1.57)	50 (1.97)	60 (2.36)	70 (2.76)	85 (3.35)	110 (4.33)	130 (5.12)	150 (5.91)
A	2.76	3.94	4.72	5.43	6.22	7.60	9.84	11.26	13.23
A ₁	2.05	2.76	3.35	3.74	4.72	5.51	7.87	9.25	10.24
AA	3.90	5.43	6.42	7.56	8.70	9.92	13.11	15.75	17.87
B	3.07	4.02	4.69	5.35	#	6.61	7.87	9.06	9.84
B ₁	2.60	3.31	3.90	4.37	4.57	5.51	6.38	7.48	8.27
C	1.18	1.61	1.93	2.36	2.36	2.40	3.05	3.54	4.13
D	0.625	0.75	1.0	1.125	1.25	1.375	1.625	1.75	2.0
	14	18 19 20	24 25	25	25 28 30	32 35	42	48	55
D ₂	9	11	14	19	19	24	28	38	42
E	1.34	1.97	2.40	2.76	3.15	3.86	4.92	5.63	6.61
F	2.76	5.51	6.30	7.09	7.87	7.87	9.84	11.81	13.78
F ₁	0.22	0.28	0.35	0.43	0.43	0.51	0.55	0.59	0.75
G	1.57	3.74	4.33	4.53	5.12	5.12	7.09	9.06	9.84
G ₁	1.65	2.36	2.76	2.76	3.15	4.33	5.12	7.09	7.09
H	2.05	2.80	3.35	3.94	4.53	5.31	6.77	7.87	9.06
H ₁	1.85	2.64	3.07	3.62	4.17	4.61	6.34	7.87	8.82
H ₂	0.35	0.59	0.69	0.85	0.75	1.04	0.98	1.00	1.50
H ₄	1.57	1.97	2.36	2.83	3.39	4.06	5.47	6.26	7.20
I	1.10	1.57	1.97	2.36	2.76	3.35	4.33	5.12	5.91
K	2.60	3.27	3.82	4.06	4.96	6.30	5.94	6.81	7.52
L	0.79	0.91	1.18	1.57	1.57	1.97	2.36	3.15	3.94
M	1.97	2.56	2.95	3.43	4.33	4.86	5.75	6.54	7.68
M ₁	0.71	0.84	1.12	1.25	1.37	1.52	1.80	1.93	2.27
M ₂	0.40	0.49	0.63	0.89	0.89	1.06	1.22	1.61	1.77
N ₁	0.19	0.19	0.25	0.25	0.25	0.31	0.38	0.38	0.5
N ₂	0.12	0.16	0.20	0.24	0.24	0.31	0.31	0.39	0.47
O	1.45	2.04	2.36	2.75	2.75	3.14	3.54	4.72	4.72
O ₁	0.09	0.13	0.13	0.18	0.18	0.19	0.23	0.35	0.35
P	1.93	3.23	3.60	4.57	4.37	3.94	5.91	5.91	6.30
P ₁	2.64	3.70	3.94	4.02	4.65	5.91	7.87	9.21	9.84
P ₂	0.75	1.61	1.67	2.20	2.01	1.54	2.85	2.36	2.17
Q	30°	60°	55°	60°	60°	60°	60°	60°	60°
R	2.20	4.53	5.12	5.91	6.50	6.50	8.46	10.43	11.81
R ₁	2.20	3.27	3.35	3.35	3.94	5.12	6.50	8.46	8.46
S	1.26	1.50	1.93	2.26	2.24	2.22	2.93	3.43	4.02
S ₁	0.24	0.35	0.47	0.47	0.55	0.59	0.67	0.75	0.79
S ₂	- 0.12	0.08	0.10	0.10	0.12	0.12	0.10	0.20	0.20
U	0.16	0.24	0.39	0.39	0.47	0.24	0.20	0.20	0.24
V	0.26 (4x)	0.35 (4x)	0.35 (4x)	0.43 (4x)	0.51 (4x)	0.51 (4x)	0.59 (8x)	0.59 (8x)	0.75 (8x)
V ₁	M6x6 (4x)	M6x9 (4x)	M8x12 (4x)	M8x15 (8x)	M8x18 (8x)	M10x20 (8x)	M12x21 (8x)	M12x24 (8x)	M14x30 (8x)
V ₂	M4x10	M4x10	M6x15	M8x20	M8x20	M8x20	M8x20	M10x22	M12x25
Y ₁	1.85	2.40	2.75	3.14	3.34	3.93	4.17	5.51	5.51
Y ₂	M5x8.5 (6x)	M5x10 (6x)	M6x10 (6x)	M6x12 (6x)	M8x16 (6x)	M8x15 (6x)	M8x15.5 (6x)	M10x20 (6x)	M10x20 (6x)
Z	0.24	0.39	0.39	0.43	0.55	0.55	0.63	0.87	0.79

- # = 5.39 (Bolted feet) or 5.51 (Integral feet)
- Motor dimensions (X, Y, Z1) refer to manufacturer's catalogue
- RS input dimensions M, O, O₁, Q, Y₁, Y₂ also apply to SRS input
- Not binding dimensions, for reference only
- Dimensions: inches (black) and mm (green)

RS-RT Worm Gearboxes

Dimensions

RA

Helical / worm

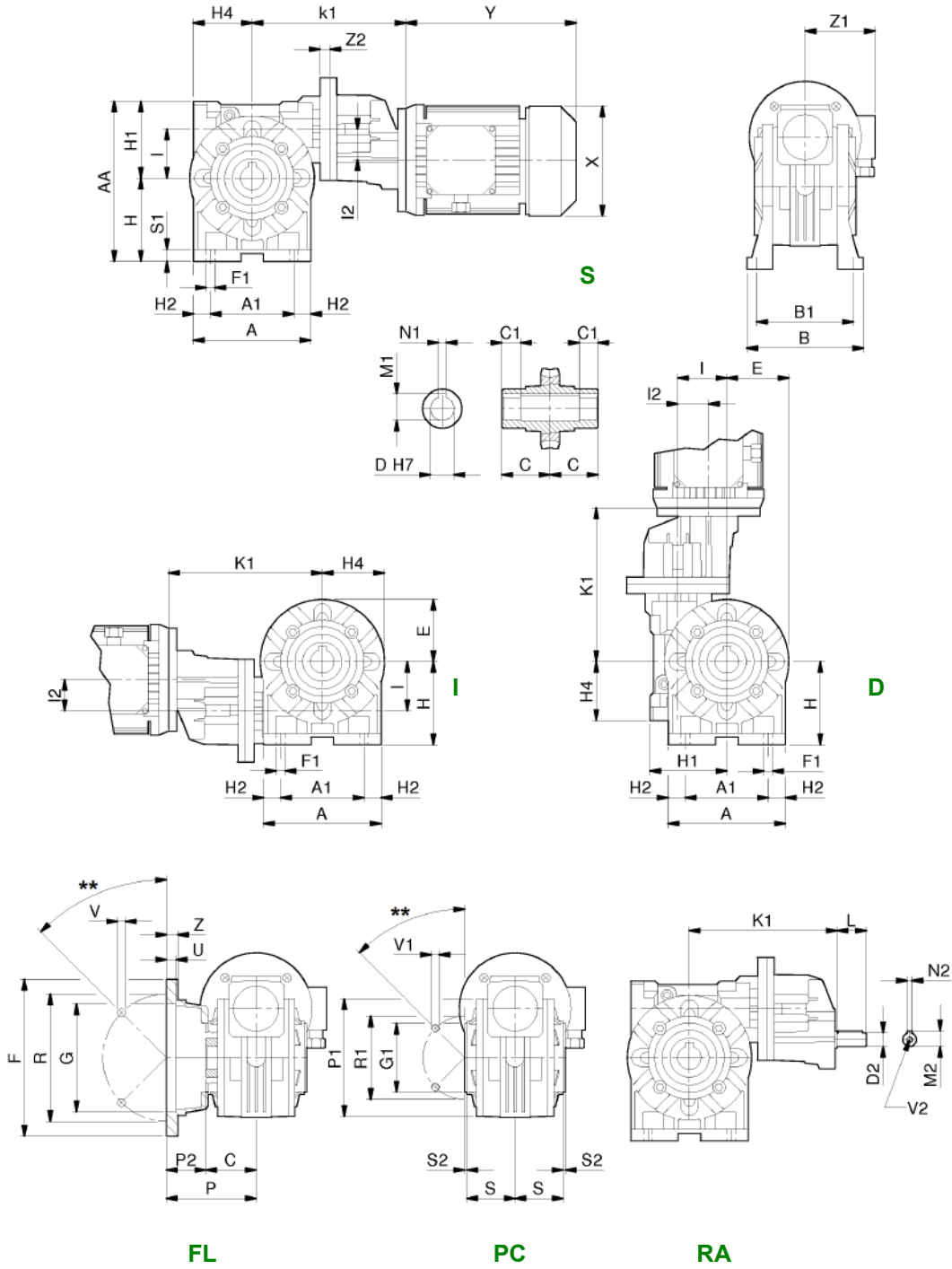

Worm Gearboxes - Series RS - RT

Helical / worm **RA** **Dimensions**

XA RS (CD)	63 (IEC input only)			71 (IEC input only)				80 (IEC input only)				100 (NEMA & IEC input)		
	40 (1.57)	50 (1.97)	60 (2.36)	50 (1.97)	60 (2.36)	70 (2.76)	85 (3.35)	60 (2.36)	70 (2.76)	85 (3.35)	110 (4.33)	110 (4.33)	130 (5.12)	150 (5.91)
A	3.94	4.72	5.43	4.72	5.43	6.22	7.60	5.43	6.22	7.60	9.84	9.84	11.26	13.23
A ₁	2.76	3.35	3.74	3.35	3.74	4.72	5.51	3.74	4.72	5.51	7.87	7.87	9.25	10.24
AA	5.43	6.42	7.56	6.42	7.56	8.70	9.92	7.56	8.70	9.92	13.11	13.11	15.75	17.87
B	4.02	4.69	5.35	4.69	5.35	#	6.61	5.35	#	6.61	7.87	7.87	9.06	9.84
B ₁	3.31	3.90	4.37	3.90	4.37	4.57	5.51	4.37	4.57	5.51	6.38	6.38	7.48	8.27
C	1.61	1.93	2.36	1.93	2.36	2.36	2.40	2.36	2.36	2.40	3.05	3.05	3.54	4.13
D	0.75	1.0	1.125	1.0	1.125	1.25	1.375	1.125	1.25	1.375	1.625	1.625	1.75	2.0
	18 19 20	24 25	25	24 25	25	25 28 30	32 35	25	25 28 30	32 35	42	42	48	55
D ₂	11	11	11	14	14	14	14	19	19	19	19	24	24	24
E	1.97	2.40	2.76	2.40	2.76	3.15	3.86	2.76	3.15	3.86	4.92	4.92	5.63	6.61
F	5.51	6.30	7.09	6.30	7.09	7.87	7.87	7.09	7.87	7.87	9.84	9.84	11.81	13.78
F ₁	0.28	0.35	0.43	0.35	0.43	0.43	0.51	0.43	0.43	0.51	0.55	0.55	0.59	0.75
G	3.74	4.33	4.53	4.33	4.53	5.12	5.12	4.53	5.12	5.12	7.09	7.09	9.06	9.84
G ₁	2.36	2.76	2.76	2.76	2.76	3.15	4.33	2.76	3.15	4.33	5.12	5.12	7.09	7.09
H	2.80	3.35	3.94	3.35	3.94	4.53	5.31	3.94	4.53	5.31	6.77	6.77	7.87	9.06
H ₁	2.64	3.07	3.62	3.07	3.62	4.17	4.61	3.62	4.17	4.61	6.34	6.34	7.87	8.82
H ₂	0.59	0.69	0.85	0.69	0.85	0.75	1.04	0.85	0.75	1.04	0.98	0.98	1.00	1.50
H ₄	1.97	2.36	2.83	2.36	2.83	3.39	4.06	2.83	3.39	4.06	5.47	5.47	6.26	7.44
I	1.57	1.97	2.36	1.97	2.36	2.76	3.35	2.36	2.76	3.35	4.33	4.33	5.12	5.91
I ₂	1.26	1.26	1.26	1.57	1.57	1.57	1.57	1.97	1.97	1.97	1.97	2.48	2.48	2.48
K ₁	6.04	6.73	6.97	6.81	7.20	8.23	8.82	8.15	9.15	9.86	10.41	12.91	13.46	14.49
L	0.91	0.91	0.91	1.18	1.18	1.18	1.18	1.57	1.57	1.57	1.57	1.97	1.97	1.97
M ₁	0.84	1.12	1.25	1.12	1.25	1.37	1.52	1.25	1.37	1.52	1.80	1.80	1.93	2.27
M ₂	0.49	0.49	0.49	0.63	0.63	0.63	0.63	0.89	0.89	0.89	0.89	1.06	1.06	1.06
N ₁	0.19	0.25	0.25	0.25	0.25	0.25	0.31	0.25	0.25	0.31	0.38	0.37	0.38	0.50
N ₂	0.16	0.16	0.16	0.20	0.20	0.20	0.20	0.24	0.24	0.24	0.24	0.31	0.31	0.31
P	3.23	3.60	4.57	3.60	4.57	4.37	3.94	4.57	4.37	3.94	5.91	5.91	5.91	6.30
P ₁	3.70	3.94	4.02	3.94	4.02	4.65	5.91	4.02	4.65	5.91	7.87	7.87	9.21	9.84
P ₂	1.61	1.67	2.20	1.67	2.20	2.01	1.54	2.20	2.01	1.54	2.85	2.85	2.36	2.17
R	4.53	5.12	5.91	5.12	5.91	6.50	6.50	5.91	6.50	6.50	8.46	8.46	10.43	11.81
R ₁	3.27	3.35	3.35	3.35	3.35	3.94	5.12	3.35	3.94	5.12	6.50	6.50	8.46	8.46
S	1.50	1.93	2.26	1.93	2.26	2.24	2.22	2.26	2.24	2.22	2.93	2.93	3.43	4.02
S ₁	0.35	0.47	0.47	0.47	0.47	0.55	0.59	0.47	0.55	0.59	0.67	0.67	0.75	0.79
S ₂	0.08	0.10	0.10	0.10	0.10	0.12	0.12	0.10	0.12	0.12	0.10	0.10	0.20	0.20
U	0.24	0.39	0.39	0.39	0.39	0.47	0.24	0.39	0.47	0.24	0.20	0.20	0.20	0.24
V	0.35 (4)	0.35 (4)	0.43 (4)	0.35 (4)	0.43 (4)	0.51 (4)	0.51 (4)	0.43 (4)	0.51 (4)	0.51 (4)	0.59 (8)	0.59 (8)	0.59 (8)	0.75 (8)
V ₁	M6x9 (4x)	M8x12 (4x)	M8x15 (8x)	M8x12 (4x)	M8x15 (8x)	M8x18 (8x)	M10x20 (8x)	M8x15 (8x)	M8x18 (8x)	M10x20 (8x)	M12x21 (8x)	M12x21 (8x)	M12x24 (8x)	M14x30 (8x)
V ₂	M4x10	M4x10	M4x10	M6x15	M6x15	M6x15	M6x15	M8x20	M8x20	M8x20	M8x20	M8x20	M8x20	M8x20
Y ₁	4.13	4.13	4.13	4.72	4.72	4.72	4.72	5.51	5.51	5.51	5.51	5.51	7.87	7.87
Z	0.39	0.39	0.43	0.39	0.43	0.55	0.55	0.43	0.55	0.55	0.63	0.63	0.71	0.79

= 5.39 (Bolted feet) or 5.51 (Integral feet)
 **= 90° for RS28 or 45° other sizes
 - Motor dimensions (X, Y, Z1) refer to manufacturer's catalogue
 - Not binding dimensions, for reference only
 - Dimensions: inches (black) and mm (green)

RS-RT Worm Gearboxes

Dimensions

RS / RS

Two-stage worm

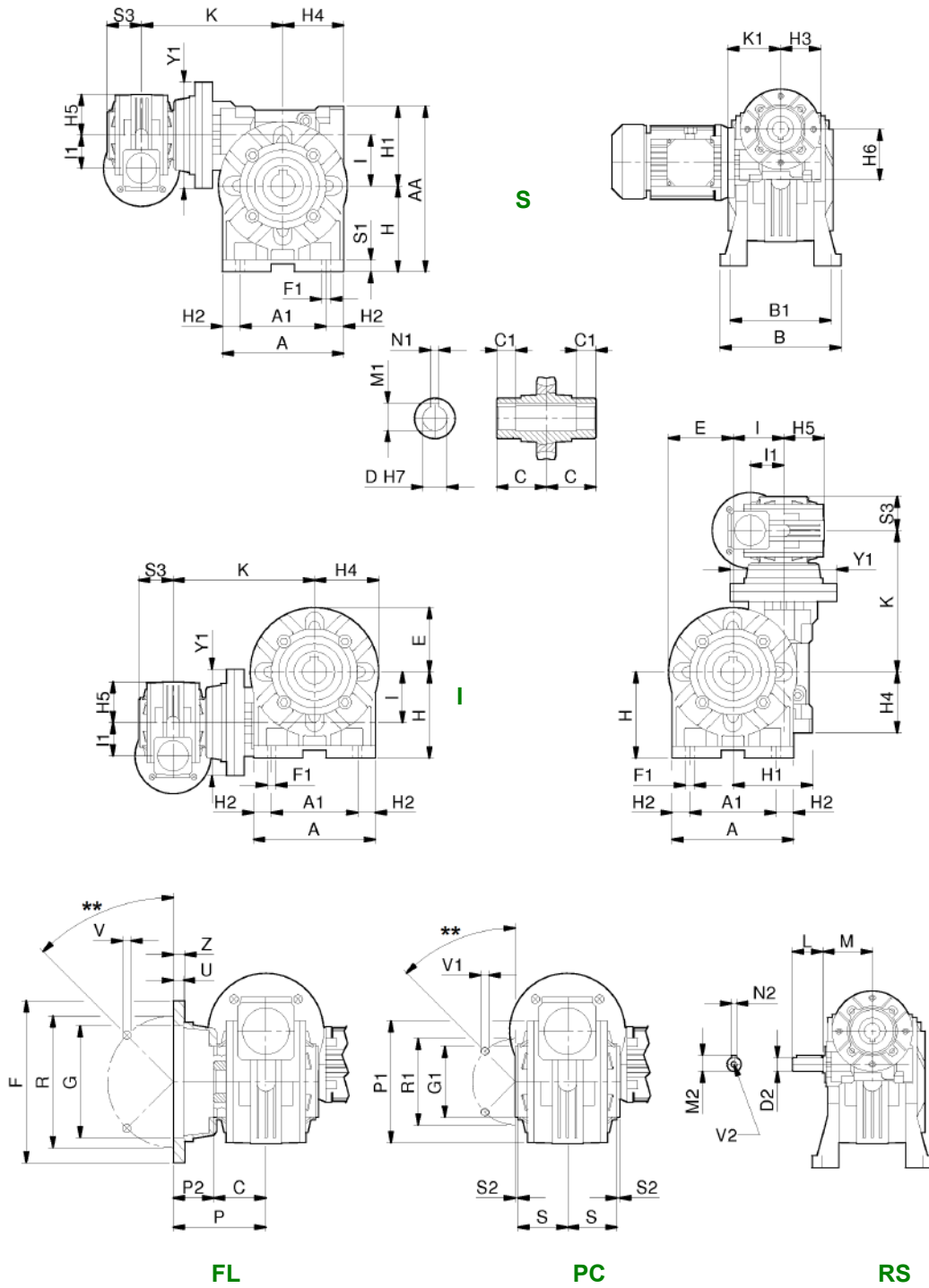

Worm Gearboxes - Series RS - RT

Two-stage worm

RS / RS

Dimensions

1st RS 2nd RS	28/				40/		50/110	60/130	70/150
	28	40	50	60	70	85			
A	2.76	3.94	4.72	5.43	6.22	7.60	9.84	11.26	13.23
A ₁	2.05	2.76	3.35	3.74	4.72	5.51	7.87	9.25	10.24
AA	3.90	5.43	6.42	7.56	8.70	9.92	13.11	15.75	17.87
B	3.07	4.02	4.69	5.35	#	6.61	7.87	9.06	9.84
B ₁	2.60	3.31	3.90	4.37	4.57	5.51	6.38	7.48	8.27
C	1.18	1.61	1.93	2.36	2.36	2.40	3.05	3.54	4.13
D	0.625	0.75	1.0	1.125	1.25	1.375	1.625	1.75	2.0
	14	18 19 20	24 25	25	25 28 30	32 35	42	48	55
D ₂	9	9	9	9	11	11	14	19	19
E	1.34	1.97	2.40	2.76	3.15	3.86	4.92	5.63	6.61
F	2.76	5.51	6.30	7.09	7.87	7.87	9.84	11.81	13.78
F ₁	0.22	0.28	0.35	0.43	0.43	0.51	0.55	0.59	0.75
G	1.57	3.74	4.33	4.53	5.12	5.12	7.09	9.06	9.84
G ₁	1.65	2.36	2.76	2.76	3.15	4.33	5.12	7.09	7.09
H	2.05	2.80	3.35	3.94	4.53	5.31	6.77	7.87	9.06
H ₁	1.85	2.64	3.07	3.62	4.17	4.61	6.34	7.87	8.82
H ₂	0.35	0.59	0.69	0.85	0.75	1.04	0.98	1.00	1.50
H ₃	1.57	1.57	1.57	1.57	1.97	1.97	2.36	2.83	3.39
H ₄	1.57	1.97	2.36	2.83	3.39	4.06	5.47	6.26	7.44
H ₅	1.34	1.34	1.34	1.34	1.97	1.97	2.40	2.76	3.15
H ₆	1.85	1.85	1.85	1.85	2.64	2.64	3.07	3.62	4.17
I	1.10	1.57	1.97	2.36	2.76	3.35	4.33	5.12	5.91
I ₂	1.10	1.10	1.10	1.10	1.57	1.57	1.97	2.36	2.76
K	3.92	4.57	5.45	5.75	7.17	7.83	9.69	9.69	11.81
K ₁	2.26	2.26	2.26	2.26	2.78	2.78	3.27	3.66	4.61
L	0.79	0.79	0.79	0.79	0.91	0.91	1.18	1.57	1.57
M	1.97	1.97	1.97	1.97	2.56	2.56	2.95	3.43	4.33
M ₁	0.71	0.84	1.12	1.25	1.37	1.52	1.80	1.93	2.27
M ₂	0.40	0.40	0.40	0.40	0.49	0.49	0.63	0.89	0.89
N ₁	0.19	0.19	0.25	0.25	0.25	0.31	0.38	0.38	0.50
N ₂	0.12	0.12	0.12	0.12	0.16	0.16	0.20	0.24	0.24
P	1.93	3.23	3.60	4.57	4.37	3.94	5.91	5.91	6.30
P ₁	2.64	3.70	3.94	4.02	4.65	5.91	7.87	9.21	9.84
P ₂	0.75	1.61	1.67	2.20	2.01	1.54	2.85	2.36	2.17
R	2.20	4.53	5.12	5.91	6.50	6.50	8.46	10.43	11.81
R ₁	2.20	3.27	3.35	3.35	3.94	5.12	6.50	8.46	8.46
S	1.26	1.50	1.93	2.26	2.24	2.22	2.93	3.43	4.02
S ₁	0.24	0.35	0.47	0.47	0.55	0.59	0.67	0.75	0.79
S ₂	-0.12	0.08	0.10	0.10	0.12	0.12	0.10	0.20	0.20
S ₃	1.18	1.18	1.18	1.18	1.61	1.61	1.93	2.36	2.36
U	0.16	0.24	0.39	0.39	0.47	0.24	0.20	0.20	0.24
V	0.24 (4x)	0.35 (4x)	0.35 (4x)	0.43 (4x)	0.51 (4x)	0.51 (4x)	0.59 (8x)	0.59 (8x)	0.75 (8x)
V ₁	M6x6 (4x)	M6x9 (4x)	M8x12 (4x)	M8x15 (8x)	M8x18 (8x)	M10x20 (8x)	M12x21 (8x)	M12x24 (8x)	M14x30 (8x)
V ₂	M4x10	M4x10	M4x10	M4x10	M4x10	M4x10	M6x15	M8x20	M8x20
Y ₁	3.15	3.15	3.15	3.54	4.53	4.53	4.33	7.09	7.87
Z	0.24	0.39	0.39	0.43	0.55	0.55	0.63	0.71	0.79

= 5.39 (Bolted feet) or 5.51 (Integral feet)

**= 90° for RS28 or 45° other sizes

- Motor dimensions refer to manufacturer's catalogue

- Not binding dimensions, for reference only

- Dimensions: inches (black) and mm (green)

RS-RT Worm Gearboxes

Dimensions

RS

Alternative mountings

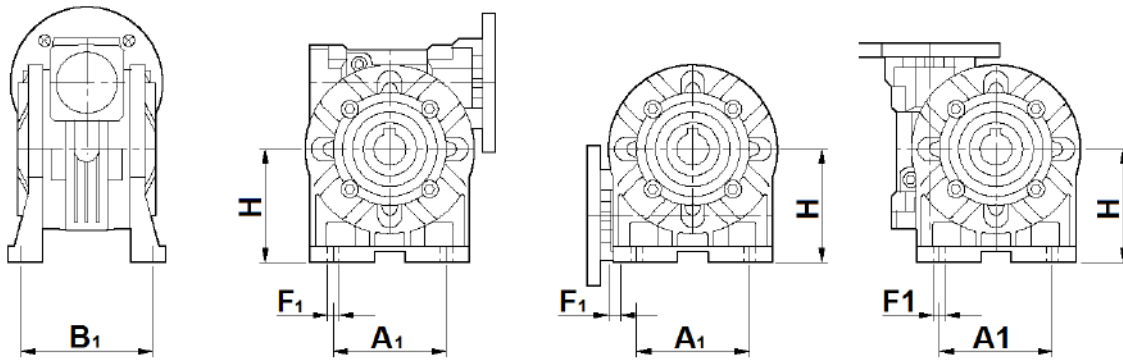

SA

IA

DA

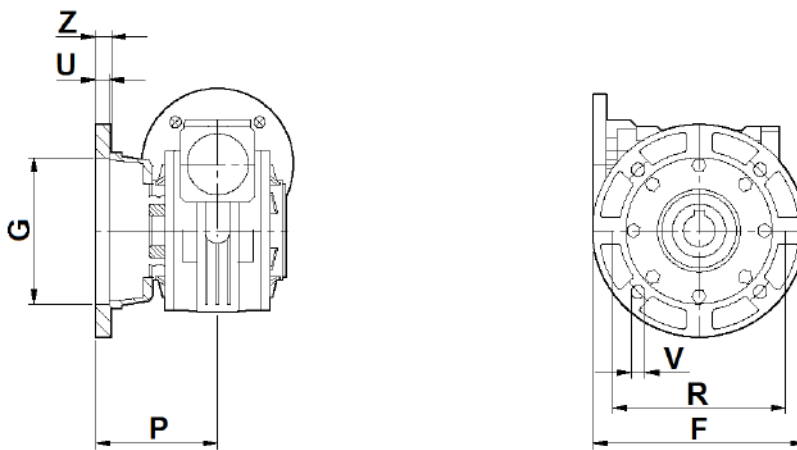

FA - FB - FR

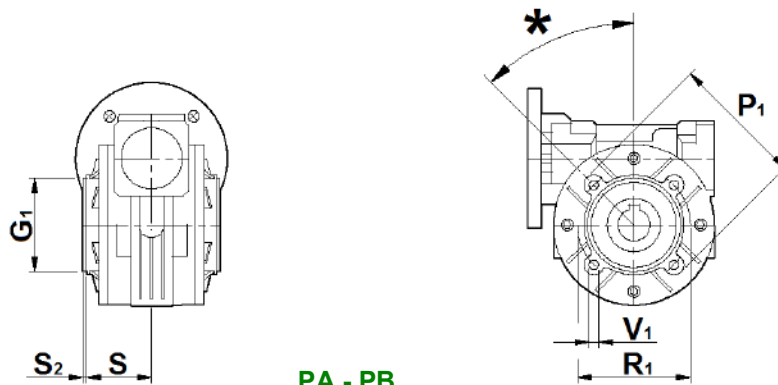

PA - PB

Worm Gearboxes - Series RS - RT

Alternative mountings	RS	Dimensions
-----------------------	----	------------

RS (CD)	28 (1.10)	40 (1.57)	50 (1.97)	60 (2.36)	70 (2.76)	85 (3.35)	110 (4.33)	130 (5.12)	150 (5.91)
SA - IA - DA									
A ₁	---	2.05	2.48	---	---	5.51	---	---	---
B ₁	---	3.19	3.88	---	---	5.75	---	---	---
F ₁	---	0.33	0.34	---	---	0.43	---	---	---
H	---	2.84	3.23	---	---	5.59	---	---	---
FA									
F	3.15	4.13	4.92	6.50	6.50	---	---	---	---
G	1.97	2.36	2.76	4.33	4.53	---	---	---	---
P	1.99	2.72	3.66	3.54	4.57	---	---	---	---
R	2.68	3.43	3.54	5.12	5.91	---	---	---	---
U	0.14	0.20	0.20	0.39	0.18	---	---	---	---
V	0.26 (4x)	0.35 (4x)	0.43 (4x)	0.41 (4x)	0.43 (4x)	---	---	---	---
Z	0.28	0.31	0.39	0.59	0.39	---	---	---	---
FB									
F	---	4.72	---	7.09	---	8.27	10.63	---	---
G	---	3.15	---	4.53	---	5.98	6.69	---	---
P	---	2.44	---	3.39	---	4.70	5.18	---	---
R	---	3.94	---	5.91	---	6.93	9.06	---	---
U	---	0.16	---	0.14	---	0.20	0.20	---	---
V	---	0.35 (4x)	---	0.43 (4x)	---	0.43 (4x)	0.52 (4x)	---	---
Z	---	0.35	---	0.47	---	0.55	0.71	---	---
FR									
F	---	---	---	---	6.30	---	---	---	---
G	---	---	---	---	4.33	---	---	---	---
P	---	---	---	---	3.33	---	---	---	---
R	---	---	---	---	5.12	---	---	---	---
U	---	---	---	---	0.18	---	---	---	---
V	---	---	---	---	0.43 (4x)	---	---	---	---
Z	---	---	---	---	0.55	---	---	---	---
PA									
G ₁	---	1.97	2.68	2.95	3.54	---	---	---	---
P ₁	---	3.74	4.33	4.09	4.92	---	---	---	---
R ₁	---	2.56	3.70	3.54	4.33	---	---	---	---
S	---	1.50	1.93	1.87	2.17	---	---	---	---
S ₂	---	0.08	0.10	0.22	0.12	---	---	---	---
V ₁	---	M6x8 (4x)	M6x12.5 (4x)	M8x14 (4x)	M8x14 (4x)	---	---	---	---
PB									
G ₁	---	---	2.36	---	2.76	---	---	---	---
P ₁	---	---	4.33	---	4.57	---	---	---	---
R ₁	---	---	2.95	---	3.35	---	---	---	---
S	---	---	1.93	---	2.64	---	---	---	---
S ₂	---	---	0.10	---	0.16	---	---	---	---
V ₁	---	---	M6x12.5 (4x)	---	M8x14 (4x)	---	---	---	---

* = 45° standard or 90° on demand
 - Not binding dimensions, for reference only
 - Dimensions: inches (black) and mm (green)

RS-RT Worm Gearboxes

Dimensions

RS

Accessories

AS
Solid single output shaft

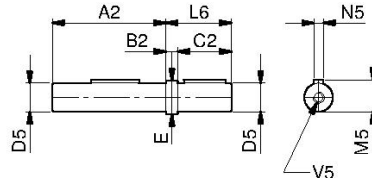

AD
Solid double output shaft

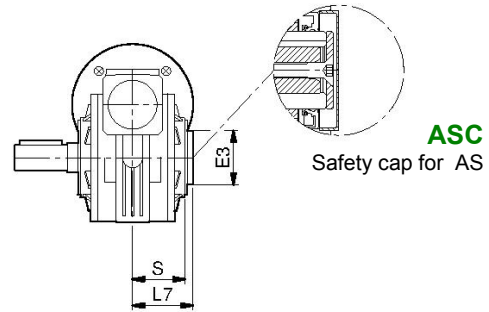
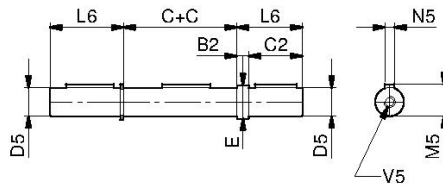

ASC
Safety cap for AS

BR
Torque arm

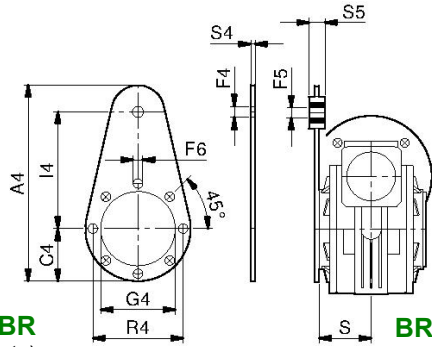

BR
(plain plate)

BRV
(with Vulkollan bush)

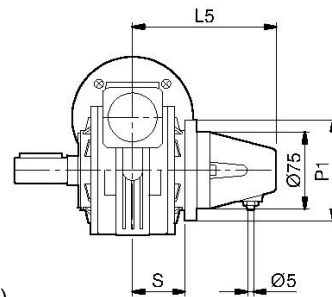

SL
Speed Limiter

TL
Torque Limiter

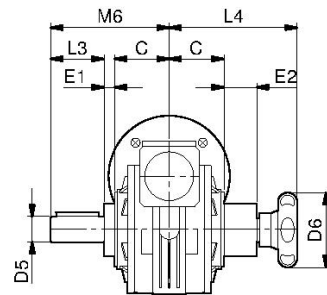

TLE (external)

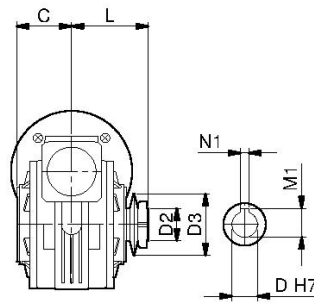

TLI (internal)

VB
NDE wormshaft extension

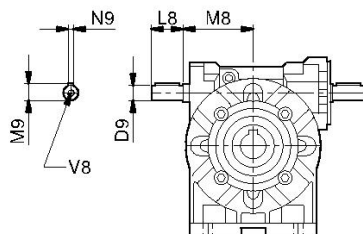

TLI
LUBRICATION

Size	US qt	litres
28	0.04	0.04
40	0.10	0.10
50	0.14	0.13
60	0.31	0.30
70	0.48	0.45
85	0.79	0.75
110	2.38	2.25

Worm Gearboxes - Series RS - RT

Accessories	RS	Dimensions
-------------	----	------------

RS (CD)	28 (1.10)	40 (1.57)	50 (1.97)	60 (2.36)	70 (2.76)	85 (3.35)	110 (4.33)	130 (5.12)	150 (5.91)	
AS & AD	A ₂	2.28	3.16	3.74	4.61	4.61	4.69	6.02	6.97	8.15
	B ₂	0.08	0.39	0.39	0.39	0.39	0.39	0.39	0.79	0.79
	C	1.18	1.61	1.93	2.36	2.36	2.40	3.05	3.54	4.13
	C ₂	1.375	1.57	1.97	2.36	2.36	2.76	3.15	3.54	3.94
	D ₅	0.625	0.75	1.0	1.125	1.25	1.375	1.625	1.75	2.0
		14	19 18	24 25	25	28 30	32 35	42	48	55
	E	0.82	0.98	1.25	1.37	1.49	1.69	1.95	2.28	2.48
	L ₆	1.42	1.97	2.37	2.76	2.76	3.15	3.54	4.33	4.33
	M ₅	0.70	0.83	1.10	1.23	1.36	1.51	1.79	1.91	2.21
	N ₅	3/16	3/16	1/4	1/4	1/4	5/16	3/8	3/8	1/2
	V ₅	1/4"-20	1/4"-20	3/8"-16	3/8"-16	1/2"-13	1/2"-13	5/8"-11	5/8"-11	3/4"-10
ASC	E ₃	1.65	2.17	2.44	2.44	2.83	3.54	4.72	---	---
	L ₇	1.42	1.91	2.19	2.70	2.64	3.03	3.35	---	---
	S	1.08	1.52	1.83	2.24	2.24	2.64	2.91	---	---
BR & BRV	A ₄	5.26	6.61	7.28	9.06	9.45	12.32	15.28	18.31	20.67
	C ₄	1.32	1.69	2.36	1.97	2.36	2.95	3.94	4.72	4.92
	F ₄	0.41	0.41	0.41	0.41	0.41	0.81	0.81	1.02	1.02
	F ₅	0.39	0.39	0.39	0.39	0.39	0.79	0.79	0.98	0.98
	F ₆	0.28	0.28	0.35	0.35	0.35	0.43	0.51	0.51	0.59
	G ₄	1.65	2.36	2.76	2.76	3.15	4.33	5.12	7.09	7.09
	I ₄	3.15	3.54	3.94	5.91	5.91	7.87	9.84	11.81	13.78
	R ₄	2.20	2.95	3.35	3.35	3.94	5.12	6.50	8.46	8.46
	S ₄	0.16	0.16	0.16	0.24	0.24	0.24	0.24	0.24	0.24
S ₅	0.59	0.59	0.59	0.79	0.79	0.98	0.98	1.18	1.18	
SL	L ₅	3.82	4.49	5.08	5.39	5.24	5.24	5.94	---	---
	P ₁	2.64	3.94	4.33	4.02	4.72	5.91	7.87	---	---
	S	1.26	1.50	1.93	2.26	2.24	2.22	2.93	---	---
TLE	D ₆	2.05	2.76	2.76	2.76	3.15	3.94	3.94	---	---
	E ₁	0.39	0.47	0.47	0.59	0.55	0.75	0.94	---	---
	E ₂	1.10	1.46	1.22	1.57	1.81	2.24	2.80	---	---
	L ₃	1.18	1.57	1.97	1.97	2.36	2.76	3.15	---	---
	L ₄	3.70	4.57	4.65	5.04	5.75	6.61	7.91	---	---
	M ₆	2.76	3.66	4.37	4.92	5.28	5.91	7.13	---	---
TLI	D	14	18	24	25	28	32	42	---	---
	D ₂	0.56 x 0.79	0.77 x 0.81	0.97 x 1.10	1.00 x 1.02	1.12 x 0.87	1.28 x 1.06	1.67 x 1.52	---	---
	D ₃	1.57	2.20	2.80	2.80	3.15	3.54	4.92	---	---
	L	1.77	2.42	3.03	3.41	3.50	3.70	4.43	---	---
	M ₁	0.61*	0.86	1.07	1.07*	1.23	1.39	1.78	---	---
	N ₁	0.20	0.24	0.31	0.31	0.31	0.39	0.47	---	---
VB	D₉	9	11	14	19	19	24	28	38	42
	L ₈	0.79	0.91	1.18	1.57	1.57	1.97	2.36	3.15	3.94
	M ₈	1.69	2.17	2.56	3.03	3.5	4.19	5.71	6.54	7.68
	M ₉	0.40	0.49	0.63	0.89	0.89	1.06	1.22	1.61	1.77
	N ₉	0.12	0.16	0.20	0.24	0.24	0.31	0.31	1.50	1.65
	V₈	M4x10	M4x10	M6x15	M8x20	M8x20	M8x20	M8x20	M8x20	M10x22

* = Undersized key
 - Not binding dimensions, for reference only
 - Dimensions: inches (black) and mm (green)

RS-RT Worm Gearboxes

Dimensions

RT

Single-stage worm

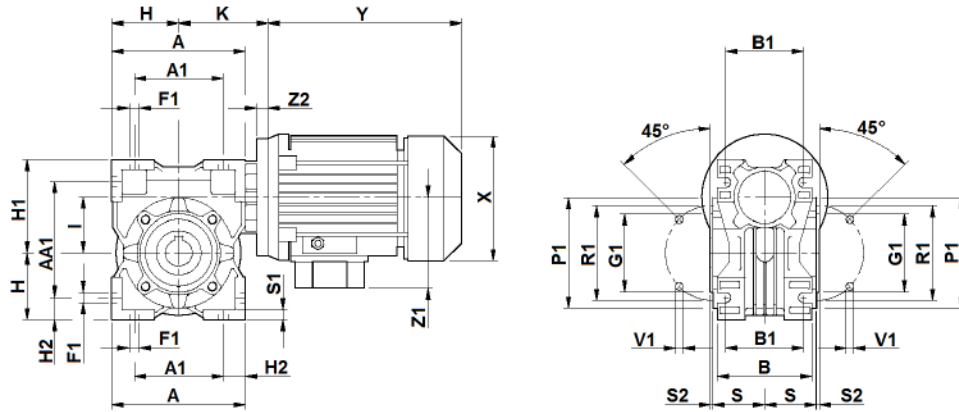

B3

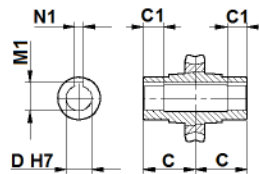

F, [FV], {FL}

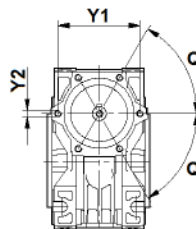
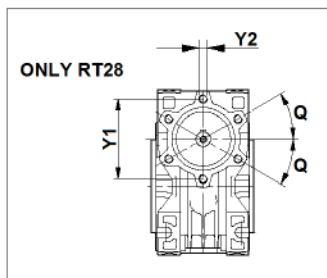
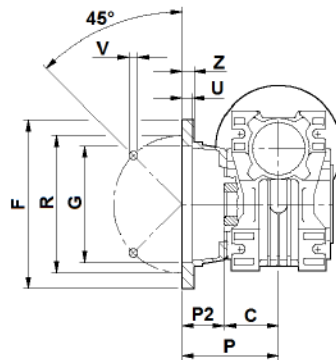

RT

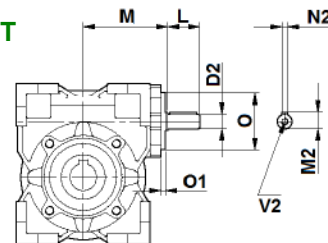

Worm Gearboxes - Series RS - RT

Single-stage worm

RT

Dimensions

RT (CD)	28 (1.10)	40 (1.57)	50 (1.97)	60 (2.36)	70 (2.76)	85 (3.35)	110 (4.33)
A	3.15	3.94	4.72	5.67	6.77	8.11	10.04
A ₁	2.13	2.76	3.15	3.94	4.72	5.51	6.69
AA	3.82	4.78	5.67	6.85	8.07	9.37	11.61
AA ₁	2.80	3.60	4.09	5.12	6.02	6.77	8.27
B	2.09	2.80	3.35	3.94	4.41	5.12	5.67
B ₁	1.73	2.36	2.76	3.35	3.54	3.94	4.53
C	1.18	1.61	1.93	2.36	2.36	2.40	3.05
D	0.625	0.75	1.0	1.125	1.25	1.375	1.625
	14	18 19 20	24 25	25	25 28 30	32 35	42
D ₂	9	11	14	19	19	24	28
F	3.15	4.33	4.92	7.09	7.87	8.27	10.63
F ₁	0.28	0.28	0.35	0.35	0.43	0.51	0.59
G	1.97	2.36	2.76	4.53	5.12	5.98	6.69
G ₁	2.17	2.36	2.76	3.15	3.74	4.33	5.12
H	1.57	1.97	2.36	2.83	3.39	4.06	5.02
H ₁	2.24	2.81	3.31	4.02	4.69	5.31	6.59
H ₂	0.51	0.59	0.79	0.87	1.02	1.30	1.67
I	1.10	1.57	1.97	2.36	2.76	3.35	4.33
K	2.60	3.27	3.82	4.06	4.96	6.30	5.94
L	0.79	0.91	1.18	1.57	1.57	1.97	2.36
M	1.97	2.56	2.95	3.43	4.33	4.86	5.75
M ₁	0.71	0.84	1.12	1.25	1.37	1.52	1.80
M ₂	0.40	0.49	0.63	0.89	0.89	1.06	1.22
N ₁	0.19	0.19	0.25	0.25	0.25	0.31	0.38
N ₂	0.12	0.16	0.20	0.24	0.24	0.31	0.31
O	1.45	2.04	2.36	2.75	2.75	3.14	3.54
O ₁	0.09	0.13	0.13	0.18	0.18	0.19	0.23
P	2.09	2.72	3.66	3.39	4.37	4.37	5.16
P ₁	2.95	3.39	3.94	4.33	5.12	6.30	7.87
P ₂	0.91	1.10	1.73	0.98	2.01	1.97	2.11
Q	30°	60°	55°	60°	60°	60°	60°
R	2.68	3.43	3.54	5.93	6.50	6.89	9.06
R ₁	2.56	2.95	3.35	3.74	4.53	5.12	6.50
S	1.08	1.52	1.83	2.24	2.24	2.64	2.91
S ₁	0.24	0.28	0.31	0.39	0.43	0.55	0.51
S ₂	0.10	0.10	0.12	0.12	0.12	0.12	0.14
U	0.39	0.16	0.20	0.26	0.47	0.24	0.20
V	0.28	0.35	0.43	0.43	0.51	0.51	0.55
V ₁	M6x10 (4x)	M6x8.5 (4x)	M8x10 (4x)	M8x16 (8x)	M8x16 (8x)	M10x18 (8x)	M10x21 (8x)
V ₂	M4x10	M4x10	M6x15	M8x20	M8x20	M8x20	M8x20
Y ₁	1.85	2.40	2.75	3.14	3.34	3.93	4.17
Y ₂	M5x8.5 (6x)	M5x10 (6x)	M6x10 (6x)	M6x12 (6x)	M8x16 (6x)	M8x15 (6x)	M8x15.5 (6x)
Z	0.28	0.23	0.39	0.39	0.55	0.63	0.71
Z ₂	0.51	0.51	0.52 - 0.73	0.55 - 0.59	0.61 - 0.69	0.61 - 0.73	0.71-0.79

- RS input dimensions M, O, O₁, Q, Y₁, Y₂ also apply to SRS input
- Motor dimensions (X, Y, Z1) refer to manufacturer's catalogue
- Not binding dimensions, for reference only
- Dimensions: inches (black) and mm (green)

RS-RT Worm Gearboxes

Dimensions

TA

Helical / worm

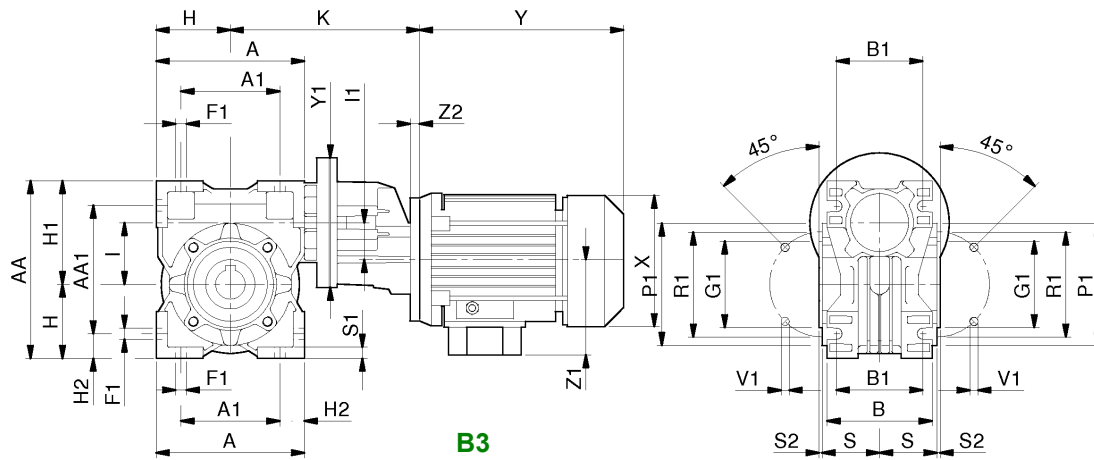

B3

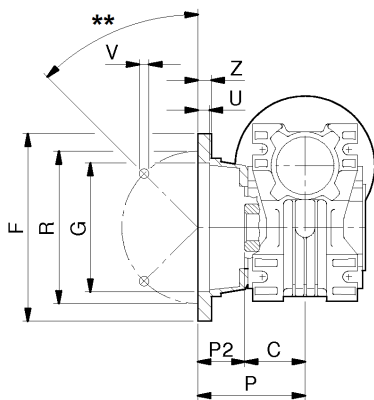
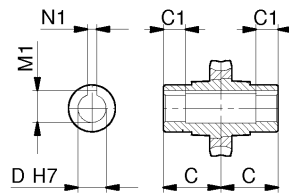

F, {FV}, {FL}

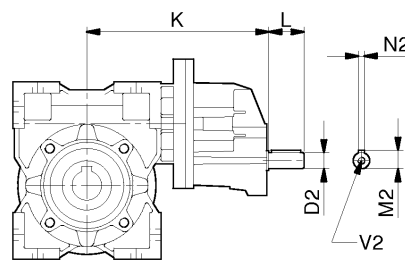

TA

Worm Gearboxes - Series RS - RT

Helical / worm

TA

Dimensions

TA RT (CD)	63 (IEC input only)			71 (IEC input only)				80 (IEC input only)				100 *
	40 (1.57)	50 (1.97)	60 (2.36)	50 (1.97)	60 (2.36)	70 (2.76)	85 (3.35)	60 (2.36)	70 (2.76)	85 (3.35)	110 (4.33)	110 (4.33)
A	3.94	4.72	5.67	4.72	5.67	6.77	8.11	5.67	6.77	8.11	10.04	10.04
A ₁	2.76	3.15	3.94	3.15	3.94	4.72	5.51	3.94	4.72	5.51	6.69	6.69
AA	4.78	5.67	6.85	5.67	6.85	8.07	9.37	6.85	8.07	9.37	11.61	11.61
AA ₁	3.60	4.09	5.12	4.09	5.12	6.02	6.77	5.12	6.02	6.77	8.27	8.27
B	2.80	3.35	3.94	3.35	3.94	4.41	5.12	3.94	4.41	5.12	5.67	5.67
B ₁	2.36	2.76	3.35	2.76	3.35	3.54	3.94	3.35	3.54	3.94	4.53	4.53
C	1.61	1.93	2.36	1.93	2.36	2.36	2.40	2.36	2.36	2.40	3.05	3.05
D	0.625	1.0	1.125	1.0	1.125	1.25	1.375	1.125	1.25	1.375	1.625	1.625
	18 19 20	24 25	25	24 25	25	25 28 30	32 35	25	25 28 30	32 35	42	42
D ₂	11	11	11	14	14	14	14	19	19	19	19	24
F	4.33	4.92	7.09	4.92	7.09	7.87	8.27	7.09	7.87	8.27	10.63	10.63
F ₁	0.28	0.35	0.35	0.35	0.35	0.43	0.51	0.35	0.43	0.51	0.59	0.59
G	2.36	2.76	4.53	2.76	4.53	5.12	5.98	4.53	5.12	5.98	6.69	6.69
G ₁	2.36	2.76	3.15	2.76	3.15	3.74	4.33	3.15	3.74	4.33	5.12	5.12
H	1.97	2.36	2.83	2.36	2.83	3.39	4.06	2.83	3.39	4.06	5.02	5.02
H ₁	2.81	3.31	4.02	3.31	4.02	4.69	5.31	4.02	4.69	5.31	6.59	6.59
H ₂	0.59	0.79	0.87	0.79	0.87	1.02	1.30	0.87	1.02	1.30	1.67	1.67
I	1.57	1.97	2.36	1.97	2.36	2.76	3.35	2.36	2.76	3.35	4.33	4.33
I ₁	1.26	1.26	1.26	1.57	1.57	1.57	1.57	1.97	1.97	1.97	1.97	1.97
K	6.04	6.73	6.97	6.81	7.20	8.23	8.82	8.15	9.15	9.86	10.41	12.91
L	0.91	0.91	0.91	1.18	1.18	1.18	1.18	1.57	1.57	1.57	1.57	1.97
M ₁	0.71	1.12	1.25	1.12	1.25	1.37	1.52	1.25	1.37	1.52	1.80	1.80
M ₂	0.49	0.49	0.49	0.63	0.63	0.63	0.63	0.89	0.89	0.89	0.89	1.06
N ₁	0.19	0.25	0.25	0.25	0.25	0.25	0.31	0.25	0.25	0.31	0.38	0.38
N ₂	0.16	0.16	0.16	0.20	0.20	0.20	0.20	0.24	0.24	0.24	0.24	0.31
P	2.72	3.66	3.39	3.66	3.39	4.37	4.37	3.39	4.37	4.37	5.16	5.16
P ₁	3.39	3.94	4.33	3.94	4.33	5.12	6.30	4.33	5.12	6.30	7.87	7.87
P ₂	1.10	1.73	0.98	1.73	0.98	2.01	1.97	0.98	2.01	1.97	2.11	2.11
R	3.43	3.54	5.93	3.54	5.93	6.50	6.89	5.93	6.50	6.89	9.06	9.06
R ₁	2.95	3.35	3.74	3.35	3.74	4.53	5.12	3.74	4.53	5.12	6.50	6.50
S	1.52	1.83	2.24	1.83	2.24	2.24	2.64	2.24	2.24	2.64	2.91	2.91
S ₁	0.28	0.31	0.39	0.31	0.39	0.43	0.55	0.39	0.43	0.55	0.51	0.51
S ₂	0.10	0.12	0.12	0.12	0.12	0.12	0.12	0.12	0.12	0.12	0.14	0.14
U	0.16	0.20	0.26	0.20	0.26	0.47	0.24	0.26	0.47	0.24	0.20	0.20
V	0.35	0.43	0.43	0.43	0.43	0.51	0.51	0.43	0.51	0.51	0.55	0.55
V ₁	M6x8 (4)	M8x10 (4)	M8x16 (8)	M8x10 (4)	M8x16 (8)	M8x16 (8)	M10x18 (8)	M8x16 (8)	M8x16 (8)	M10x18 (8)	M10x21 (8)	M10x21 (8)
V ₃	M4 x 10	M4 x 10	M4 x 10	M6 x 15	M6 x 15	M6 x 15	M6 x 15	M8 x 20	M8 x 20	M8 x 20	M8 x 20	M8 x 20
Y ₁	4.13	4.13	4.13	4.72	4.72	4.72	4.72	5.51	5.51	5.51	5.51	5.51
Z	0.24	0.39	0.39	0.39	0.39	0.55	0.63	0.39	0.55	0.63	0.71	0.71
Z ₂	0.51	0.51	0.51	0.51	0.51	0.51	0.51	0.55	0.55	0.55	0.55	0.55

* NEMA & IEC input

** = 90° for RT28 or 45° other sizes

- Motor dimensions (X, Y, Z1) refer to manufacturer's catalogue

- Not binding dimensions, for reference only

- Dimensions: inches (black) and mm (green)

RS-RT Worm Gearboxes

Dimensions

RT / RT

Two-stage worm

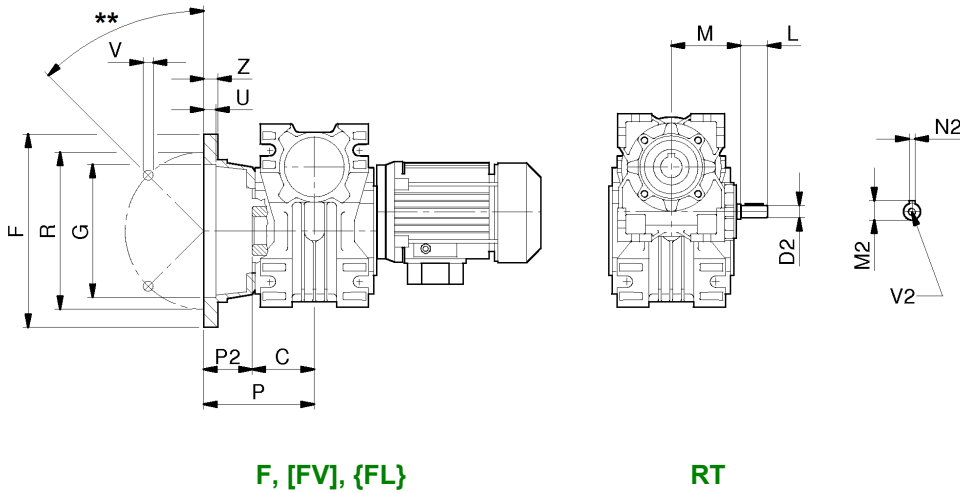
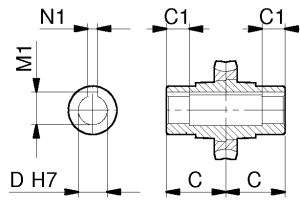
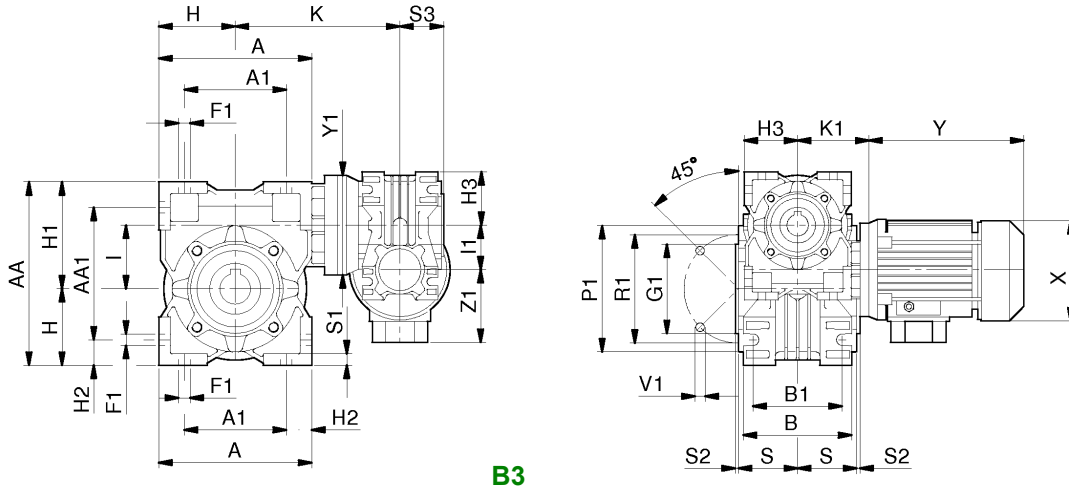

Worm Gearboxes - Series RS - RT

Two-stage worm

RT / RT

Dimensions

1st RT 2nd RT	28 /				40 /		50 /
	28	40	50	60	70	85	110
A	3.15	3.94	4.72	5.67	6.77	8.11	10.04
A ₁	2.13	2.76	3.15	3.94	4.72	5.51	6.69
AA	3.82	4.78	5.67	6.85	8.07	9.37	11.61
AA ₁	2.80	3.60	4.09	5.12	6.02	6.77	8.27
B	2.09	2.80	3.35	3.94	4.41	5.12	5.67
B ₁	1.73	2.36	2.76	3.35	3.54	3.94	4.53
C	1.18	1.61	1.93	2.36	2.36	2.40	3.05
D	0.625	0.75	1.0	1.125	1.25	1.375	1.625
	14	18 19 20	24 25	25	25 28 30	32 35	42
D ₂	9	9	9	9	11	11	14
F	3.15	4.33	4.92	7.09	7.87	8.27	10.63
F ₁	0.28	0.28	0.35	0.35	0.43	0.51	0.59
G	1.97	2.36	2.76	4.53	5.12	5.98	6.69
G ₁	2.17	2.36	2.76	3.15	3.74	4.33	5.12
H	1.57	1.97	2.36	2.83	3.39	4.06	5.02
H ₁	2.24	2.81	3.31	4.02	4.69	5.31	6.59
H ₂	0.51	0.59	0.79	0.87	1.02	1.30	1.67
H ₃	1.57	1.57	1.57	1.57	1.97	1.97	2.36
I	1.10	1.57	1.97	2.36	2.76	3.35	4.33
I ₁	1.10	1.10	1.10	1.10	1.57	1.57	1.97
K	3.13	3.92	5.55	5.73	5.65	7.83	7.99
K ₁	2.26	2.26	2.26	2.26	2.78	2.78	3.27
L	0.79	0.79	0.79	0.79	0.91	0.91	1.18
M	1.97	1.97	1.97	1.97	2.56	2.56	2.95
M ₁	0.71	0.84	1.12	1.25	1.37	1.52	1.80
M ₂	0.40	0.40	0.40	0.40	0.49	0.49	0.63
N ₁	0.20	0.24	0.31	0.31	0.31	0.39	0.47
N ₂	0.12	0.12	0.12	0.12	0.16	0.16	0.20
P	2.09	2.72	3.66	3.39	4.37	4.37	5.16
P ₁	2.95	3.39	3.94	4.33	5.12	6.30	7.87
P ₂	0.91	1.10	1.73	0.98	2.01	1.97	2.11
R	2.68	3.43	3.54	5.93	6.50	6.89	9.06
R ₁	2.56	2.95	3.35	3.74	4.53	5.12	6.50
S	1.08	1.52	1.83	2.24	2.24	2.64	2.91
S ₁	0.24	0.28	0.31	0.39	0.43	0.55	0.51
S ₂	0.10	0.10	0.12	0.12	0.12	0.12	0.14
S ₃	1.18	1.18	1.18	1.18	1.61	1.61	1.93
U	0.39	0.16	0.20	0.26	0.47	0.24	0.20
V	0.28	0.35	0.43	0.43	0.51	0.51	0.55
V ₁	M6x10 (4x)	M6x8,5 (4x)	M8x10 (4x)	M8x16 (8x)	M8x16 (8x)	M10x18 (8x)	M10x21 (8x)
V ₂	M4x10	M4x10	M4x10	M4x10	M4x10	M4x10	M6x15
Y ₁	3.15	3.54	3.54	3.54	4.72	4.72	4.72
Z	0.28	0.24	0.39	0.39	0.55	0.63	0.71

** = 90° for RT28 or 45° other sizes

- Not binding dimensions, for reference only

- Dimensions: inches (black) and mm (green)

RS-RT Worm Gearboxes

Dimensions

RT

Accessories

AS

Solid single output shaft

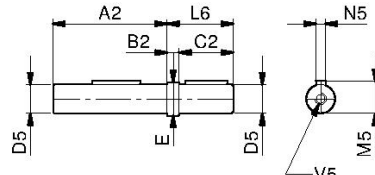

AD

Solid double output shaft

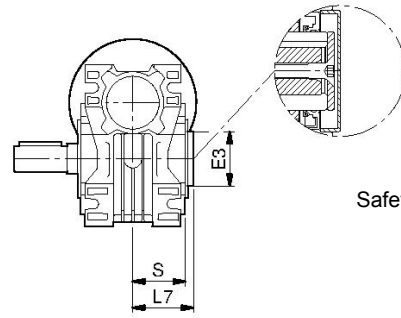
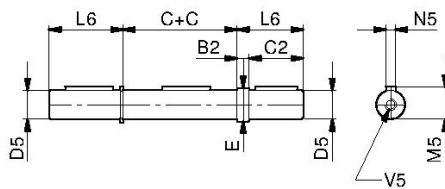

ASC

Safety cap for AS

BT

Torque arm

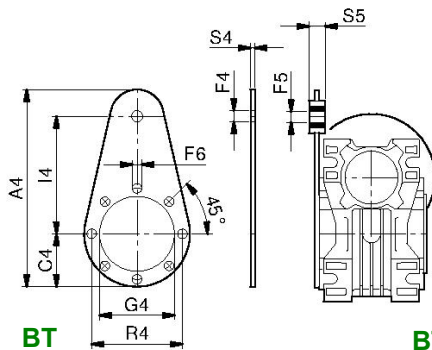

BT
(plain sheet)

BTV
(with Vulkollan bush)

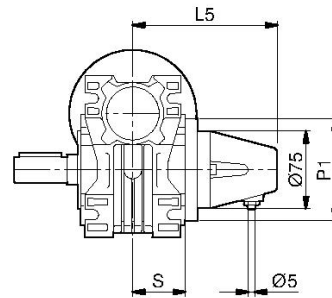

SL
Speed Limiter

TL

Torque Limiter

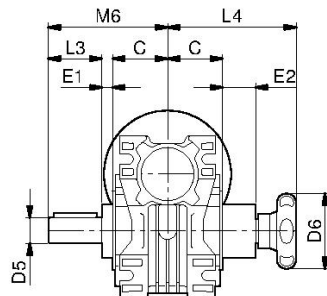

TLE (external)

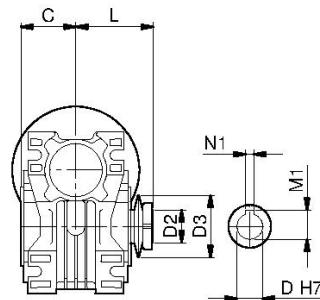

TLI (internal)

VB

NDE wormshaft extension

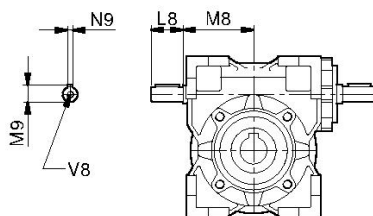

TLI
LUBRICATION

Size	US qt	litres
28	0.04	0.04
40	0.10	0.10
50	0.14	0.13
60	0.31	0.30
70	0.48	0.45
85	0.79	0.75
110	2.38	2.25

Worm Gearboxes - Series RS - RT

Accessories	RT	Dimensions
-------------	----	------------

RT (CD)	28 (1.10)	40 (1.57)	50 (1.97)	60 (2.36)	70 (2.76)	85 (3.35)	110 (4.33)
AS & AD A ₂	2.28	3.16	3.74	4.61	4.61	4.69	6.02
B ₂	0.08	0.39	0.39	0.39	0.39	0.39	0.39
C	1.18	1.61	1.93	2.36	2.36	2.40	3.05
C ₂	1.375	1.57	1.97	2.36	2.36	2.76	3.15
D ₅	0.625	0.75	1.0	1.125	1.25	1.375	1.625
	14	19 18	24 25	25	28 30	32 35	42
E	0.82	0.98	1.25	1.37	1.49	1.69	1.95
L ₆	1.42	1.97	2.37	2.76	2.76	3.15	3.54
M ₅	0.70	0.83	1.10	1.23	1.36	1.51	1.79
N ₅	3/16	3/16	1/4	1/4	1/4	5/16	3/8
V ₅	1/4"-20	1/4"-20	3/8"-16	3/8"-16	1/2"-13	1/2"-13	5/8"-11
ASC E ₃	1.97	2.05	2.44	2.95	3.54	3.94	4.72
L ₇	1.42	1.91	2.19	2.70	2.64	3.03	3.35
S	1.08	1.52	1.83	2.24	2.24	2.64	2.91
BT & BTV A ₄	5.43	6.61	7.28	9.25	11.61	12.32	15.28
C ₄	1.50	1.69	2.36	2.17	2.56	2.95	3.94
F ₄	0.41	0.41	0.41	0.41	0.41	0.81	0.81
F ₅	0.39	0.39	0.39	0.39	0.39	0.79	0.79
F ₆	0.28	0.28	0.35	0.35	0.35	0.47	0.51
G ₄	2.17	2.36	2.76	3.15	3.74	4.33	5.12
I ₄	3.15	3.94	3.94	5.91	7.87	7.87	9.84
R ₄	2.56	2.95	3.35	3.74	4.53	5.12	6.50
S ₄	0.16	0.16	0.16	0.24	0.24	0.24	0.24
S ₅	0.59	0.59	0.59	0.79	0.79	0.98	0.98
SL L ₅	3.78	4.45	4.84	5.24	5.24	5.47	5.91
P ₁	3.07	3.54	3.94	4.33	5.12	6.30	7.87
S	1.08	1.52	1.83	2.24	2.24	2.64	2.91
TLE D ₆	2.05	2.76	2.76	2.76	3.15	3.94	3.94
E ₁	0.39	0.47	0.47	0.59	0.55	0.75	0.94
E ₂	1.10	1.46	1.22	1.57	1.81	2.24	2.80
L ₃	1.18	1.57	1.97	1.97	2.36	2.76	3.15
L ₄	3.70	4.57	4.65	5.04	5.75	6.61	7.91
M ₆	2.76	3.66	4.37	4.92	5.28	5.91	7.13
TLI D	14	18	24	25	28	32	42
D ₂	0.56x0.79	0.77x0.81	0.96x1.10	1.00x1.02	1.12x0.87	1.28x1.06	1.67x1.52
D ₃	1.57	2.20	2.80	2.80	3.15	3.54	4.92
L	1.77	2.42	3.03	3.41	3.50	3.70	4.43
M ₁	0.61*	0.86	1.07	1.07*	1.23	1.39	1.78
N ₁	0.20	0.24	0.31	0.31	0.31	0.39	0.47
VB D ₉	9	11	14	19	19	24	28
L ₈	0.79	0.91	1.18	1.57	1.57	1.97	2.36
M ₈	1.69	2.17	2.56	3.03	3.5	4.19	5.71
M ₉	0.40	0.49	0.63	0.89	0.89	1.06	1.22
N ₉	0.12	0.16	0.20	0.24	0.24	0.31	0.31
V ₈	M4x10	M4x10	M6x15	M8x20	M8x20	M8x20	M8x20

* = Undersized key
 - Not binding dimensions, for reference only
 - Dimensions: inches (black) and mm (green)

RS-RT Worm Gearboxes

Dimensions

XA

Single-stage attachment

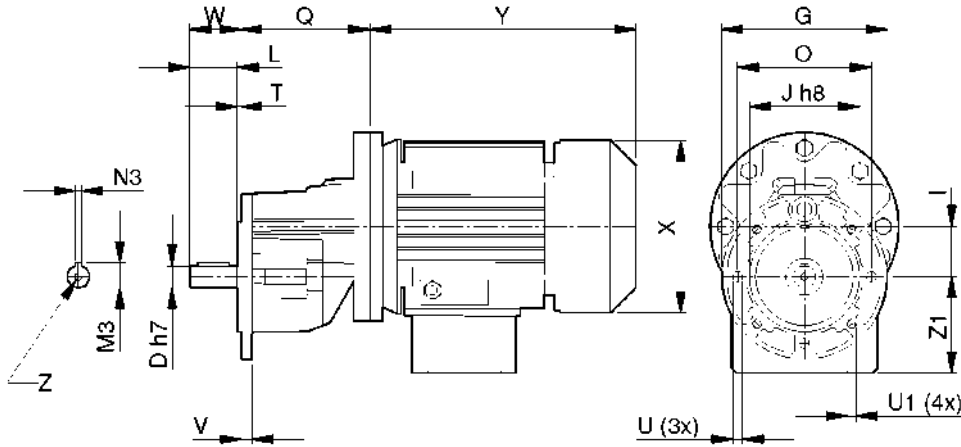

FXA dimensions	D	G	I	J h ₈	L	O	Q	U	U1	T	V	W	Z
63	14	105	1.26	70	1.18	85	3.27	0.26	M6	0.10	0.28	1.28	M5x10
71	19	120	1.57	80	1.57	100	3.54	0.22	M6	0.10	0.30	1.67	M8x20
80	24	140	1.97	95	1.95	115	4.49	0.35	M6	0.10	0.41	2.05	M8x20
100	28	200	2.48	130	2.26	165	6.97	0.41	0.41	0.10	0.47	2.36	M10x22

- FXA 63, 71 and 80 with IEC input only
- FXA100 with NEMA and IEC input

FXA weights	lb	US qt	litres
63	2.23	0.04	0.04
71	4.28	0.06	0.06
80	6.36	0.11	0.10
100	15.25	0.21	0.20

- Motor dimensions (X, Y, Z1) refer to manufacturer's catalogue
- Not binding dimensions, for reference only
- Dimensions: inches (black) and mm (green)

Worm Gearboxes - Series RS - RT

Back driving - Reversibility - Irreversibility

In case a worm gearbox is back-driven by using the worm wheel as input, efficiency is lower than forward-driving and back-drive efficiency can be reduced to zero obtaining a self-locking, or irreversible gear set.

When back-driving the worm gear, internal friction tends to lock the mesh, and the bigger the applied torque the mesh friction increases proportionally augmenting the lockage at the same time.

The most obvious example is during braking or slowing-down a weight where the inertial load will try to back-drive the worm shaft.

A worm gear is intended as static self-locking drive when the lead angle (β) is lower than the friction angle (arc tangent of friction coefficient) but tooth contact can be dynamic even when the mesh velocity is zero, as vibrations in a non-rotating gear set can induce motion in the tooth contact area.

To provide a safety factor, gearing lead angles smaller than 3 degrees are recommended for full self-locking condition, and lead angles bigger than 10 degrees for full reversibility condition, according to the below cross-table between lead angles and self-locking.

Lead angle	Static self-locking & Reversibility	
$\beta > 20^\circ$	Full reversibility	Examples (Gearing lead angle "β" from the table below) - FRT50 1/7 $\beta = 23$ degrees & 52 minutes → Full reversibility - FRS60 1/20 $\beta = 11$ degrees & 18 minutes → High reversibility - FRT85 1/56 $\beta = 4$ degrees & 45 minutes → Good reversibility Poor static self-locking - FRT40 1/56 $\beta = 3$ degrees & 25 minutes → Poor reversibility/ Good static self-locking - FRT70 1/80 $\beta = 2$ degrees & 51 minutes → Full static self-locking
$10^\circ < \beta < 20^\circ$	High reversibility	
$5^\circ < \beta < 10^\circ$	Good reversibility Poor static self-locking	
$3^\circ < \beta < 5^\circ$	Poor reversibility Good static self-locking	
$1^\circ < \beta < 3^\circ$	Full static self-locking	

Size	Reduction ratio / Lead angle " β "											
	5	7	10	15	20	28	40	49	56	70	80	100
RS / RT 28	29°33'	23°11'	16°41'	11°18'	10°23'	6°06'	5°14'	4°19'	3°03'	2°27'	2°37'	2°20'
RS / RT 40	30°57'	21°36'	16°41'	11°18'	8°31'	5°39'	4°17'	3°48'	3°25'	3°01'	2°51'	2°38'
RS / RT 50	30°57'	23°52'	16°41'	11°18'	8°59'	6°19'	4°31'	4°14'	3°42'	2°44'	2°51'	2°17'
RS / RT 60	36°32'	25°33'	19°0'	12°55'	11°18'	6°49'	5°42'	5°11'	3°55'	3°38'	2°51'	2°51'
RS / RT 70	34°01'	26°51'	18°38'	12°40'	11°18'	7°12'	5°42'	4°48'	4°05'	3°16'	2°51'	2°38'
RS / RT 85	34°47'	26°05'	19°09'	13°02'	11°18'	6°58'	5°52'	4°52'	4°45'	3°48'	3°14'	2°40'
RS/RT 110	---	26°22'	20°43'	14°09'	11°18'	7°04'	5°42'	4°43'	4°29'	3°54'	3°39'	2°34'
RS 130	---	26°57'	21°20'	14°06'	13°05'	7°14'	6°18'	5°18'	6°20'	4°33'	3°30'	3°40'
RS 150	---	25°33'	21°48'	16°22'	13°24'	7°35'	7°07'	5°48'	6°11'	4°17'	3°45'	3°43'

RS-RT Worm Gearboxes

Direction of rotation

RS - RT

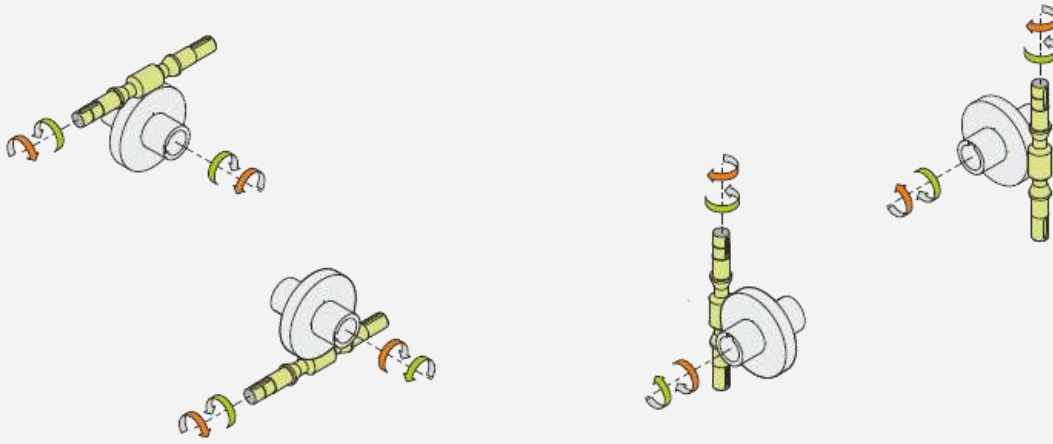

RA - TA

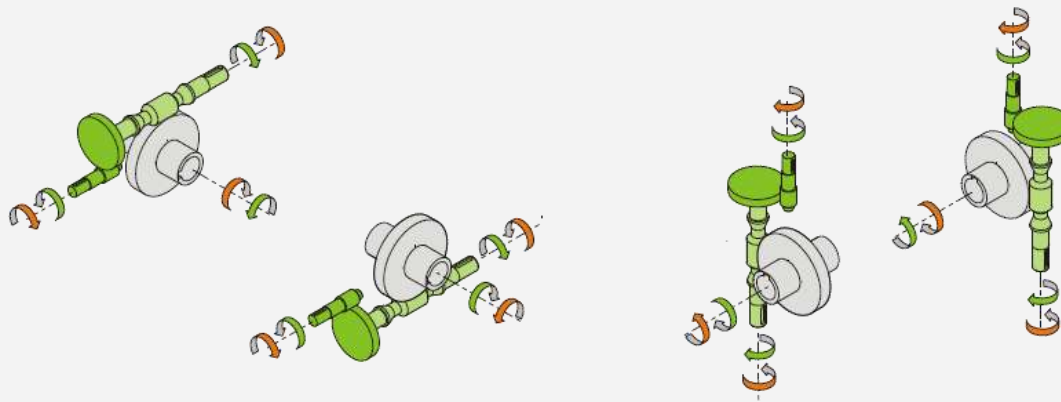

RS/RS - RT/RT

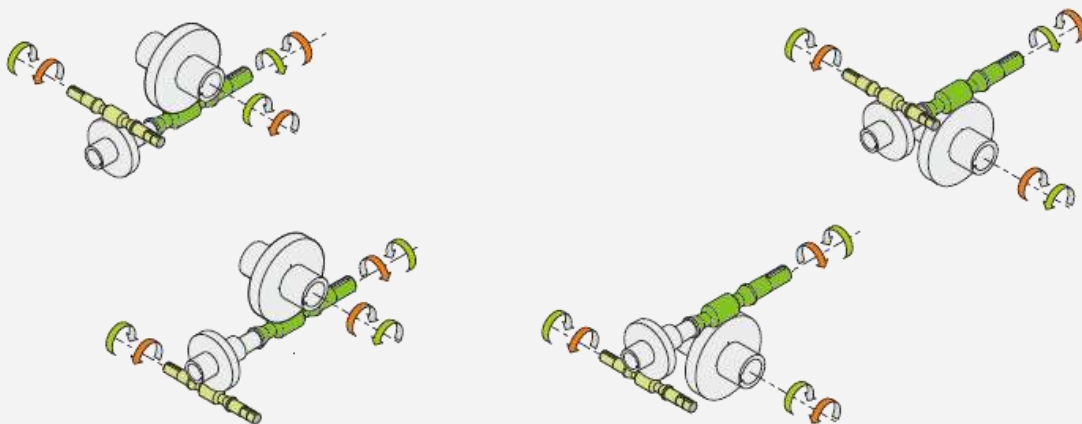

Worm Gearboxes - Series RS - RT

RS - RT - XA

Component parts

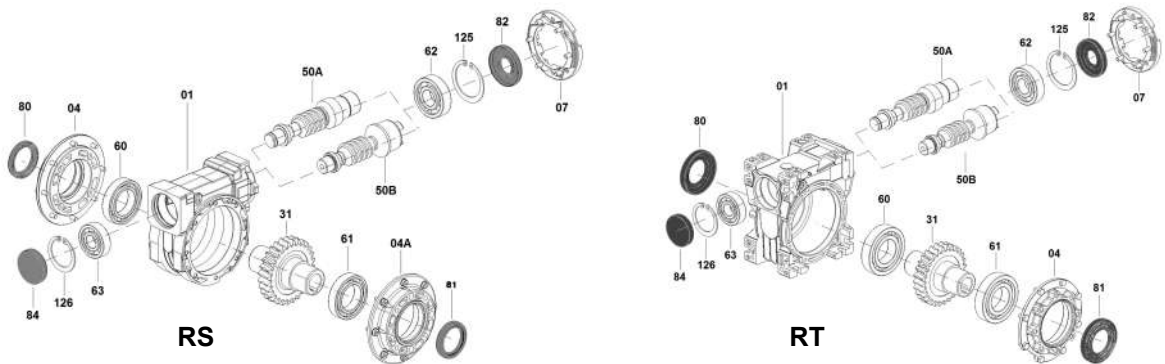

Item	Description	Item	Description	Item	Description
01	Body	50B	Worm shaft "G"	81	Oil seal
04	Side cover RT	60	Bearing	82	Oil seal
04A	Side cover RS	61	Bearing	84	Oil seal RCA
07	Motor flange	62	Bearing	125	Snap ring
31	Worm wheel	63	Bearing	126	Snap ring
50A	Worm shaft NEMA/IEC	80	Oil seal		

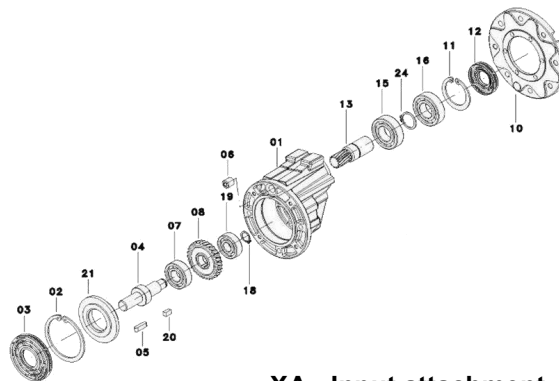

XA - Input attachment

Item	Description	Item	Description	Item	Description
01	Body	08	Gear	18	Snap ring
02	Snap ring	10	Motor flange	19	Bearing
03	Oil seal	11	Snap ring	20	Key
04	Output shaft	12	Oil seal	21	Adapter
05	Key	13	Pinion	24	Snap ring
06	Screw	15	Bearing		
07	Bearing	16	Bearing		

RS-RT Worm Gearboxes

Imperial	CONVERSION FACTORS	Metric
1 lb = 4.45 N 1 lb = 0.454 kg 1 oz = 0.028 kg	Mass & Force	1 N = 0.225 lb 1 kg = 2.205 lb 1 kg = 35.27 oz
HP (60Hz) = kW (50Hz) × 1.341 × 1.2 HP (50Hz) = kW (50Hz) × 1.341 HP = in-lb × rpm : (63025 x eff.)	Power	kW (50Hz) = HP (60Hz) × 0.745 × 0.833 kW (50Hz) = HP (50Hz) × 0.745 kW = Nm × rpm / (9550 × eff.)
1 in-lb = 0.113 Nm 1 ft-lb = 1.355 Nm ft-lb = 108 × k × HP × eff. × ratio in-lb = 63025 × HP × eff. / rpm = 9 × k × HP × eff. × ratio = 8000 × k × HP × eff. / output speed (where k= motor pole number, i.e. 2, 4, 6, 8)	Torque	1 Nm = 8.851 in-lb 1 Nm = 0.738 ft-lb Nm = 9550 × kW × eff. / rpm
1 qt (US) = 0.946 litre	Volume	1 litre = 1.057 qt (US)

Abstract of OPERATION AND MAINTENANCE INSTRUCTIONS

(complete manual on www.varvel.com)

Under the terms of the Machine Directive 2006/42/EC and relevant Guidelines, the speed gearboxes and variators are considered as “machines’ separate elements not having a specific application and meant for being incorporated onto the machine. The complete machine and equipped with such components must comply with the essential and relevant requisites for safety and health preservation” of the mentioned Directive.

Installation

Check if the unit to be installed, is properly selected to perform the required function and that its mounting position complies with the order.

The nameplate reports such information.

Check mounting stability to ensure the unit runs without vibrations or overloads.

Running

The unit may be connected for clockwise or counter-clockwise rotation.

The unit must be stopped as soon as defective running or unexpected noise occur, remove the faulty part or return the unit to the factory for checking.

If the faulty part is not replaced, other parts can also be affected, causing more severe damage and making the identification of initial cause more difficult.

Maintenance

Although the units are no-load run tested in the factory before despatch, it is recommended not to run them at maximum load for the first 20-30 running hours to allow the proper running in.

The gearboxes are delivered already filled with long-life synthetic oil and, in case of replacement or topping, do not mix with mineral lubricants.

Handling

When hoisting, use relevant housing locations or eyebolts if provided, or foot or flange holes.

Never hoist on any moving part.

Painting

Carefully protect oil seals, coupling faces and shafts when units are re-painted.

Long-term storage

For storage longer than 3 months, apply anti-oxidants onto shafts and machined surfaces, and protective grease on oil seal lips.

Product’s Environmental Management

In conformity with Environmental Certification ISO 14001, we recommend the following to dispose of our products:

- scraped components of the units to be delivered to authorized centres for metal object collection;
- oils and lubricants drained from the units to be delivered to Exhausted Oil Unions;
- packages (pallets, carton boxes, paper, plastic, etc.) to lead into regeneration/recycling circuits as far as possible, by delivering separate waste classes to authorized companies.

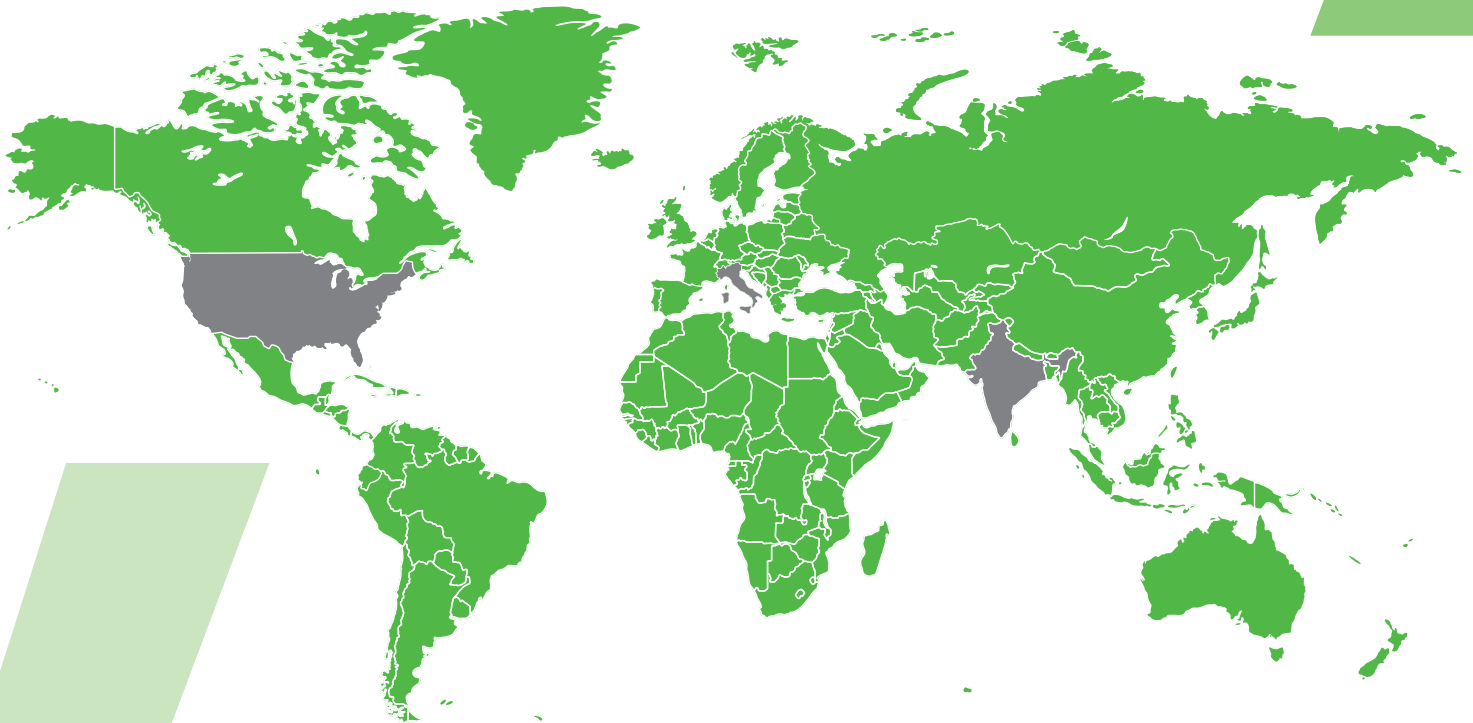

2 Foreign subsidiaries, one in India, one in the USA



60 Over 60 years of history and international success



100 A global network with over 100 commercial partners

India subsidiary:
MGM-VARVEL Power Transimission Pvt Ltd
Warehouse N. G3 and G4 | Ground Floor
Indus Valley's Logistic Park | Unit 3
Mel Ayanambakkam Vellala Street
Chennai - 600 095 | Tamil Nadu | INDIA
info@mgmvarvelindia.com
www.mgmvarvelindia.com

USA subsidiary:
VARVEL USA LLC
2815 Colonnades Court
Peachtree Corners, GA 30071 | USA
T 770-217-4567 | F 770-255-1978
info@varvelusa.com
www.varvelusa.com



technology
made in Italy 

VARVEL SpA | Via 2 Agosto 1980, 9 | Loc. Crespellano | 40053 Valsamoggia (BO)
Italy | T+39 051 6721811 | F +39 051 6721825 | varvel@varvel.com

www.varvel.com

